



6.1.2 The effective leadership is reflected in various institutional practices such as decentralization and participative management

Supporting document for a case study showing practicing decentralisation and participative management in the institution to organize institutional level event "Annual Techno fest".

S No.	Description	Page No.
1.	Approval of the Almanac in the Academic council for implementation	2-9
2.	Circulation of Almanac among the stake holders which includes Annual Fests	10-10
3.	Issuing of circular regarding Annual techno, sports and cultural fest. budget to the head of the institution for the necessary approvals	11-11
4.	Placing the discussion in the student activity advisory committee at the management level.	12-14
5.	Principal Nominates core committee and other sub committees for fest (Chairman's of sub committees are usually HoDs/Senior Faculty).	15-39
6.	Principal being the advisor of the student techno fest shall convene a meeting to discuss the responsibilities of various sub committees for smooth conducting of the fest.	40-42
7.	Chairman's of the sub committees shall convene meeting with their respective.	43-48
8.	Chairman of all committees submits the proposed	49-55
9.	The Head of the Institution presents the budgetary requirements with the present of the CBIT Society for approval.	
10.	The administration shall inform to the respective subcommittee chairman's regarding the budget approvals.	
11.	After the completion of the event, sub-committee chairmen submit the statements of expenditure incurred, to the head of the institution through core committee	
12.	Further, the administration shall proceed auditing process for the expenditure incurred in conducting the event.	
13.	The core committee shall consolidate and submits the report about the student techno fest to the head of the institution	56-131



Principal
Chaitanya Bharathi Institute of Technology
(Autonomous)
Gandipet, Hyderabad-500 075.



CHAITANYA BHARATHI
INSTITUTE OF TECHNOLOGY (A)

Kokapet (Village), Gandipet, Hyderabad, Telangana-500075 www.cbit.ac.in



COMMITMENT
RESEARCH
INNOVATION AND
EDUCATION

42
years

Dt.04.06.2021

ACADEMIC COUNCIL

Minutes of the 10th Meeting of Academic Council of Chaitanya Bharathi Institute of Technology (A), Hyderabad, held on 03.06.2021 at 10:00 AM on Google meet.

Members present:

1. Prof. G. P. Saradhi Varma, Principal & Chairman, Academic Council
2. Prof. M. Gopal Naik, Prof. & Former Head, Dept. of Civil Engg. OUCE
3. Prof. N. Venkat Reddy, Prof., Dept. of Mech. Engg., IITH
4. Prof. K. Shyamala, Director, Academic Audit Cell, Osmania University
5. Prof. V. V. Basava Rao, Principal, UCT, Osmania University
6. Sri Jagadeesh Kuncham, Vice-President, Caggemini, Hyderabad
7. Prof. N. V. Koteswara Rao, Director-IQAC
8. Prof. Suresh Pubboju, Director-AEC&COE
9. Prof. K. Krishnaveni, Director - Academics
10. Prof. M. Swami Das, Joint Director -Academics (Informatics)
11. Prof. K. Jagannadha Rao, Jt. Director-SA&P & Head, Dept. of Civil Engg.
12. Prof. Y. Rama Devi, Head, Dept. of CSE
13. Prof. D. Krishna Reddy, Head, Dept. of ECE
14. Prof. G. Suresh Babu, Head, Dept. of EEE
15. Prof. K. Radhika, Head, Dept. of IT
16. Prof. P.V.R. Ravindra Reddy, Head, Dept. of Mechanical Engg.
17. Dr. Y. Rajasri, I/c-Head, Dept. of Biotechnology
18. Dr. P.V. Naga Prapura, I/c-Head, Dept. of Chemical Engg.
19. Prof. K. Lakshmi, Head, Dept. of Chemistry
20. Prof. P. Raji Reddy, Head, Dept. of Mathematics
21. Prof. B. Sreenivasa Reddy, Head, Dept. of Physics
22. Dr. D. L. Sreenivas Reddy, Head, Dept. of MCA
23. Dr. S. Saraswathi, I/c-Head, SMS
24. Dr. M. Koti Reddy, Professor, Dept. of Civil Engg.
25. Prof. P.V. Prasad, Controller of Examinations
26. Dr. A. Supraja Reddy, Associate Professor, Dept. of ECE
27. Dr. N. Vasantha Gowri, Assistant Professor, Dept. of EEE
28. Mrs. A. Vijaya lakshmi, Asst. Prof., Dept. of English

Leave of Absence:

1. Sri Y. Sreenivasa Rao, Project Director, RCI, DRDO, Hyderabad
2. Mr. Vagish Dixit, Convenor, Education & Skills Panel, CII, Telangana, CEO,ALPLA
3. Sri B. Jaipal Reddy, MD, Apollo Computing Laboratories Pvt. Ltd., Hyderabad

G. P. Saradhi Varma

Principal

Chaitanya Bharathi Institute of Technology
(Autonomous)

Gandipet, Hyderabad 500 075.



	The Director-Academics Dr. K. Krishnaveni welcomed all the members of CBIT Academic Council and requested the Principal to preside over the meeting.
Opening remarks	Dr. G. P. Saradhi Varma, Principal, CBIT(A), started the meeting with Opening remarks and initiated the proceedings of the 10 th meeting of Academic Council.
Agenda Item No. 1	Confirmation of the Minutes of 9th Meeting of Academic Council held on 12.09.2020
Minutes	Minutes of Ninth (9 th) Meeting of Academic Council held on 12.09.2020 were presented by Director-Academics and the same were confirmed.
Agenda Item No. 2	To approve the Minutes of Common BoS Meeting held on 06.02.2021, for Item Nos. : 2, 3 & 4 of the respective Meeting.
Minutes	Minutes of Common BoS Meeting held on 06.02.2021, for Item Nos.: 2& 3 were approved. The Item 4 - about division and grades was approved with the modifications as given below. a. The Division "Pass" is to be removed b. 'CGPA 5.0 to 6.5' shall be redefined as "Second Class"
Agenda Item No. 3	To approve respective Department "BoS Meeting Minutes" for I. Scheme of III to VIII Semesters of all B.E. / B.Tech. Programs (R-20) II. Syllabus for III and IV Semesters of all the B.E. / B.Tech. Programs (R-20) III. Scheme and Syllabus for I, II, III & IV Semesters of M.E. / M.Tech. Programs (R-20)
a)	To approve "Minutes of BoS Meeting" of B.E. (Civil Engineering) and M.E. (Structural Engineering)
Minutes	The Minutes of BoS Meeting of Civil Engineering Department were presented by the Head and the same were approved by the Council
b)	To approve "Minutes of BoS Meeting" for B.E. (Computer Science & Engineering) and M.Tech. (CSE)
Minutes	The Minutes of BoS Meeting of Computer Science & Engineering Department for BE (CSE) & M. Tech. (CSE) were presented by the Head and the same were approved by the Council
c)	To approve "BoS Meeting Minutes" for B.E. - CSE (Artificial Intelligence and Machine Learning)
Minutes	The Minutes of BoS Meeting of B.E.-CSE (Artificial Intelligence and Machine Learning) were presented by the Head and were approved by the Council
d)	To approve "BoS Meeting Minutes" for B.E. - CSE (IOT & Cyber Security including Blockchain Technology)

Principal



Chaitanya Bharathi Institute of Technology
(Autonomous)
Gandipet, Hyderabad-500 075.

Minutes	:	The minutes of BoS Meeting of B.E. - CSE (IOT & Cyber Security including Blockchain Technology) were presented by the Head and were approved by the Council.
	e)	To approve "BoS Meeting Minutes" for B.E. (Information Technology)
Minutes	:	The Minutes of BoS meeting of B.E. - Information Technology Department were presented by the Head and the same were approved by the Council.
	f)	To approve "BoS Meeting Minutes" for B.E. -Artificial Intelligence and Data Science and M.Tech. (AI&DS)
Minutes	:	The Minutes of BoS meeting of B.E. - Artificial Intelligence and Data Science and M.Tech. (AI&DS) were presented by the Head and the same were approved.
	g)	To approve "BoS Meeting Minutes" for B.E. (Electrical & Electronics Engineering) and M.E.(PS&PE)
Minutes	:	The Minutes of BoS meeting of B.E (EEE) and M.E(PSPE) were presented by the Head and the same were approved.
	h)	To approve "BoS Meeting Minutes" for B.E. (Electronics & Communication Engineering), M.E. (Communication Engineering) and M.E. (ES & VLSI)
Minutes	:	The Minutes of BoS meeting of B.E. - Electronics & Communication Engineering, M.E. - Communication Engineering and M.E. - ES & VLSI were presented by the Head and were approved.
	i)	To approve "BoS Meeting Minutes" for B.E. (Mechanical Engineering), M.E. - CAD/CAM and M.E. (Thermal Engg.)
Minutes	:	The Minutes of BoS meeting of B.E. - Mechanical Engineering, M.E. (CAD/CAM) and M.E. (Thermal Engg.) were presented by the Head and were approved.
	j)	To approve "BoS Meeting Minutes" for B.Tech. (Chemical Engineering)
Minutes	:	The Minutes of BoS meeting of B.Tech. (Chemical Engineering) were presented by the Head and approved by the Council with the following suggestion. ➤ One (1) hour tutorial to be given for the subject for 'Mass Transfer Operations - II'
	k)	To approve "BoS Meeting Minutes" for B.Tech. (Biotechnology)
Minutes	:	The Minutes of BoS meeting of B.Tech. - Biotechnology were presented by the Head and the same were approved by the Council
	l)	To approve "BoS Meeting Minutes" for Mathematics
Minutes	:	The Minutes of BoS meeting of the Department of Mathematics were presented by the Head and the same were approved by the Council
	m)	To approve "BoS Meeting Minutes" for English
Minutes	:	The minutes of BoS meeting of the Department of English are presented by the concerned and were approved by the Council

P. A. ...

Principal

Chaitanya Bharathi Institute of Technology
(Autonomous)
Gandipet, Hyderabad-500 075.



n)	To approve Internship Guidelines (R-20) - Annexure-I			
Minutes	: The Guidelines for Internship drafted were approved by the Council			
Agenda Item No. 4	: To approve Almanac of the following Programs for the Academic Year 2021-2022 a) III and IV Semesters of B.E. / B.Tech. b) V to VIII Semesters of B.E. / B.Tech. and V & VI Semesters of MCA c) III and IV Semesters of M.E. / M.Tech. d) III and IV Semesters of MBA and MCA e) I and II Semesters of all B.E. / B.Tech, M.E. / M.Tech., MCA and MBA based on the guidelines of AICTE & UGC (COVID Pandemic)			
Minutes	: The tentative Almanacs for the above said Programs prepared by the Director-Academics were discussed and were approved by the Council.			
Agenda Item No. 5	: Any other item with the permission of the Chair			
(i)	Corrections in MCA Rule book a. Content to be added in Rule book (Page -10 PDF) <table border="1" data-bbox="528 927 1270 1025"> <tr> <td>4.</td> <td>To attend the SEE of IV semester</td> <td> i) Regular study of Semester - IV ii) Student must secure at least 40% off maximum marks of CIE of Semester -IV </td> </tr> </table> b. To make corrections in the Scheme presented in the Rule book (replacing with the Scheme approved in BoS meeting) c. To make necessary corrections in page numbers	4.	To attend the SEE of IV semester	i) Regular study of Semester - IV ii) Student must secure at least 40% off maximum marks of CIE of Semester -IV
4.	To attend the SEE of IV semester	i) Regular study of Semester - IV ii) Student must secure at least 40% off maximum marks of CIE of Semester -IV		
Minutes	: The item was discussed and approved by the Council			
(ii)	Corrections in MBA Rule book d. Note: III semester Electives are given in the separate table [FE- First Elective, SE- Second Elective] It should be below III-Semester table instead of II-Semester table e. Content to be added in Rule book (Page -10 PDF) <table border="1" data-bbox="528 1435 1270 1534"> <tr> <td>4.</td> <td>To attend the SEE of IV semester</td> <td> iii) Regular study of Semester - IV iv) Student must secure at least 40% off maximum marks of CIE of Semester -IV </td> </tr> </table> f. Correction in the marks allotted to comprehensive Viva-voce (page-7) Maximum marks of Comprehensive Viva Voce '50' is to be replaced with '100' g. Correction in the Page no.7 Title change & add to description "Career Guidance" is to be changed to "Personality Development and Career Guidance". "Personality Development helps the students in being aware of their characteristics and identifying Career choices most suitable for them. This course enables students to bring out their capabilities and strengths in	4.	To attend the SEE of IV semester	iii) Regular study of Semester - IV iv) Student must secure at least 40% off maximum marks of CIE of Semester -IV
4.	To attend the SEE of IV semester	iii) Regular study of Semester - IV iv) Student must secure at least 40% off maximum marks of CIE of Semester -IV		

P. Anand
Principal

Chaitanya Bharathi Institute of Technology
(Autonomous)
Gandipet, Hyderabad-500 075.



making themselves aware of their inner self and become more confident to face the Competitive World." Career Guidance encompasses information, guidance and counseling services

h. Correction in P.No.8

For Theory Course, add the Performance column and last row for theory course, add table for Laboratory & deletion of content

Academic Performance	Letter grade	Grade points	Performance
90% ≤ Marks ≤ 100%	S	10	Outstanding
80% ≤ Marks < 90%	A	9	Excellent
70% ≤ Marks < 80%	B	8	Very Good
60% ≤ Marks < 70%	C	7	Good
50% ≤ Marks < 60%	D	6	Average
40% ≤ Marks < 50%	E	5	Pass
0% ≤ Marks < 40%	F	0	Fail
	Ab	0	Absent

For Laboratory/Personality Development & Career Guidance/Internship Courses /Project/Comprehensive Viva Voce I & II

Academic Performance	Letter grade	Grade points	Performance
90% ≤ Marks ≤ 100%	S	10	Outstanding
80% ≤ Marks < 90%	A	9	Excellent
70% ≤ Marks < 80%	B	8	Very Good
60% ≤ Marks < 70%	C	7	Good
50% ≤ Marks < 60%	D	6	Average/Pass
0% ≤ Marks < 50%	F	0	Fail
	Ab	0	Absent

A Student obtaining Grade F shall be considered failed and will be required to reappear the examination. For non-credit course 'Satisfactory' or 'Unsatisfactory' shall be indicated instead of the letter grade and this will not be counted for the computation of SGPA/CGPA. For the non-credit Courses, the Students must have secured 'Satisfactory' for the award of degree along with other requirements.

i. Correction in "XI. Assessment Procedure for Awarding Marks table (P.No.9)"

The duration of Semester End Examination for Lab Course is to be changed to "3 Hours" in place of 2 Hours.

j. Add content in p.no.9 (below *CIE: Continuous Internal Evaluation (Max. Marks: 40)

P. A. ...
Principal

Chaitanya Bharathi Institute of Technology
(Autonomous)
Gandipet, Hyderabad-500 075.



Out of 40 CIE marks:

- 1) 20 marks are based on the average of two Internal Tests/Mid-Term Examinations (weightage for each test is 20 marks of one hour duration). The question paper for internal tests will be in two parts, Part-A and Part-B. Part A is for three (3) questions and is compulsory, and carries six (6) marks. Part-B carries fourteen (14) marks, student has to answer two questions among three questions and each question carries seven (7) marks.
- 2) 10 marks are allotted for Assignment(s). Assignment methods can be opted as per the scope of the course. There are two methods:
 - a) Case Studies/Book Review/Relevant Industry visit & Report/ Course end project/ Open ended problem, student has to submit one assignment consisting of 10 marks; or
 - b) Two Assignments (should be from BL4 and BL5), average of two assignments, each of 10 marks.
- 3) Three slip tests (5 marks each) shall be conducted and average of the best two slip tests will be considered.
- 4) Attendance percentage carries marks as mentioned in CIE table (Maximum 5 marks).

k. Correction in the (Page no.10)

~~**Semester End Examination (SEE) (Max. Marks: 60) last para , deletion~~

~~For non-credit courses also the minimum pass mark is 40% and the students who secures more than are equal to 40% of maximum mark, then the student will be awarded with 'Satisfactory' otherwise they will be awarded with 'Not-satisfactory'. The students must have secured with 'Satisfactory' in these non-credit courses for the award of degree.~~

Content to be added in the Promotion Rules table

4	To attend the SEE of IV-Semester	i. Regular Course of Study of IV-Semester. ii. Student must secure at least 40% of Maximum Marks of CIE of IV Semester.
---	----------------------------------	--

l. Correction in P.No.11

3. i) In special cases and for sufficient cause shown, the ~~Director~~ Principal may, on the specific recommendation of the Head of the Department, condone the deficiency in attendance to the extent of 10% on medical grounds subject to submission of medical certificate and payment of condonation fee.

ii) However, in respect of women candidates who seek condonation of attendance due to pregnancy, the ~~Director~~ Principal may condone the deficiency in attendance

Principal

**Chaitanya Bharathi Institute of Technology
(Autonomous)**

Gandipet, Hyderabad-500 075.



CGPA	DIVISION
7.5 and above	First Class with distinction
6.5 and less than 7.5	First Class
5.0 and less than 6.5	Second Class
4.0 and less than 5.0	Pass
Less than 4.0	Fail

m. Correction in " XVII. AWARD OF DIVISION" (Page no.13)

Candidates are eligible for the award of Distinction with I Class with a CGPA of 7.0 7.5 and above if and only if the student clears all the subjects in all Semesters in single attempt.

Minutes : The item was discussed and approved by the Council

(iii) Corrections in M.E. - M.Tech. Rule book (R20)

n. Correction in point no. 8(Page- 9):

"A student is eligible for appearing semester end examination (viva-voce) for 'Industrial Project /Dissertation Phase II, if the student earns fifty two (52) credits of I, II and III semesters of M.E/M.Tech. program and should get the PASS grade in non-credit courses."

Minutes : The item was approved by the Council

(iv) To consider Extension of period for Completion of B.E. and M.E. Course/ Program beyond the stipulated period-AEC

The recommendation of the respective departmental Heads (ECE and Civil Engg.) for grant of extension for the following B.E./M.E. students to complete the course beyond normal four/two years period as under:

S. No.	Roll No.	Name of the Student	Name of the Course/ Program	Admitted batch	Completed batch as per Course/ Program Rules & Regulations	Requests of the Students and Recommendations of the Respective HoDs
4 Year B.E. Degree Course / Program						
1	1601-12-735-156	Mohammed Riyaz	BE(ECE)	2012-2013	2019-2020 (8 years)	Extension of Two more years
2 Year M.E. Degree Course / Program						
2	1601-16-741-703	G Niketh Reddy	ME (Earth Quake Engg.)	2016-17	2019-2020 (4 years)	Extension of One more year
3	1601-16-741-704	G S Prashcel Varma	ME (Earth Quake Engg.)	2016-17	2019-2020 (4 years)	Extension of One more year

Minutes : The item was discussed and recommended by the Council for further approval.

(Signature)
Principal

Chaitanya Bharathi Institute of Technology
(Autonomous)
Gandipet, Hyderabad-500 075.



(v)	<ul style="list-style-type: none"> ➤ The Members appreciated the effort put in by the Departments in providing the specializations in case of Professional Electives. ➤ The Members suggested to rethink on the Credit distribution in case of Core Engineering branches particularly in final Semester, i.e, to shift some of the Courses from previous Semesters to final Semester.
Concluding remarks	Prof. G. P. Saradhi Varma, Principal & Chairman, Academic Council, thanked all the external members for sparing their valuable time and precious suggestions.
Vote of Thanks	There being no other item for discussion, the meeting concluded with vote of thanks by Dr. K. Krishnaveni, Director - Academics.

G. P. Saradhi Varma

Dr. G. P. Saradhi Varma
Principal & Chairman-Academic Council

To
All the Members of Academic Council

Note: The members are requested to offer their comments, if any, within a week from the date of receipt of this communication. If no comments are received, the minutes will be taken as confirmed.

(Handwritten signature in green ink)

Principal
Chaitanya Bharathi Institute of Technology
(Autonomous)
Gandipet, Hyderabad-500 075.





No. /CBIT-AEC/2020

Dt.25-01-2021

REVISED ALMANAC 2020-21

III to VIII Semesters of B.E/B.Tech.

ODD SEMESTER		
1	Commencement of Class work	10-08-2020
2	Research Day	23-08-2020(Online) SUNDAY
3	I-Class Test	12-10-2020 to 15-10-2020
4	SUDHEE-2020	---
5	Last Date of Instruction	28-11-2020
6	II-Class Test	Shall be completed before 28-11-2020
7	Preparation Holidays , Conduct of Even Semester Class test-2 and Semester End Practical Examinations	30-11-2020 to 15-12-2020
8	Conduct of Even Semester End Examinations	16-12-2020 to 02-01-2021
9	Preparation Holidays and conduct of Semester End Practical Examinations(odd semester)	03-01-2021 to 16-01-2021
11	Conduct of Odd Semester End Exams of 2020-21	18-01-2021 to 02-02-2021

EVEN SEMESTER		
1	Registration of Courses	04-02-2021 to 05-02-2021
2	Commencement of Class work	08-02-2021
3	SHRUTHI- 2021	03-03-2021to 6-03-2021
4	Class Test-I	29-03-2021 to 31-03-2021
5	Last Date of Instruction	22-05-2021
6	Class Test-II	24-05-2021 to 26-05-2021
7	Preparation Holidays	27-05-2021 to 02-06-2021
8	Commencement of Semester End Examinations (Semester End Practical Examinations will be conducted after Theory Examinations)	03-06-2021
9	Summer Vacation	7-06-2021
10	Commencement of Odd-Semester for the Academic Year 2021-2022	12-07-2021(Tentative)

Prepared by 
The Director-Academics

PRINCIPAL

To
All the Directors, Joint Directors, Heads of the Departments, Sections Heads.
The Head-HR &CoE



Principal

**Chaitanya Bharathi Institute of Technology
(Autonomous)
Gandipet, Hyderabad-500 075.**



CHAITANYA BHARATHI INSTITUTE OF TECHNOLOGY (A), HYDERABAD-75

No. CBIT/Admn./003/2021

Dt. 18.01.2021

CIRCULAR

It is proposed to organize the Annual Techno, Sports & Cultural Fest-2021 (Sudhee & Shruthi) from 3rd March to 6th March, 2021. This is to inform all Directors, Joint Directors, Heads of the Departments, Heads of Sections, Staff and Students that the Sudhee-2021 will be conducted on 3rd & 4th March, 2021 and the Sports and the Cultural Day, 2021 (Shruthi) will be held on 5th & 6th March, 2021 respectively.

In this regard, the following are the Core Committees for organising the Annual Techno, Sports & Cultural Fest-2021 (SUDHEE & SHRUTHI).

SUDHEE-2021 :

Advisor	:	Dr. G. P. Saradhi Varma, Principal, CBIT
Chairman	:	Dr. N.V. Koteswara Rao, Prof., ECE Department
Co-Chairman	:	Dr. M. Koti Reddy, Prof., Civil Engg. Department
Convener	:	Dr. P. Prabhakar Reddy, Prof., Mech. Engg. Department
Co-Convener	:	Dr. M. Trupthi, Assistant Prof., IT Department

SHRUTHI-2021 :

Advisor	:	Dr. G. P. Saradhi Varma, Principal, CBIT
Chairman	:	Prof. P. Sreenivasa Sarma, Director-SA&P
Co-Chairman	:	Dr. G. Suresh Babu, Prof. & Head, EEE Department
Convener	:	Dr. K. Jagannadha Rao, Prof., Civil Department
Co-Convener	:	Sri Sreenivasulu Andoju, Asst. Prof., English Department

All Heads of the Departments / Sections are advised to keep ready the soft copies of the achievements of both Staff & Students and all the events conducted from Shruthi, 2020 till date for the Academic Year 2020-21 so as to submit the same to the undersigned.

PRINCIPAL

To

All Heads of the Departments, Heads of Sections for information and with a request to arrange for circulation among the Staff and Students under their control.

All Directors, Joint Directors, HR, CoE, Librarian & PD - for information & N/a.

C.C. to the Chairmen, Co-Chairmen & Conveners & Co-conveners, Sudhee & Shruthi - 2021, for information.



Principal

Chaitanya Bharathi Institute of Technology
(Autonomous)
Gandipet, Hyderabad-500 075.



CHAITANYA BHARATHI INSTITUTE OF TECHNOLOGY (A)
STUDENT ACTIVITIES ADVISORY COMMITTEE

Minutes of the meeting held on 22-01-2021 at 2 PM in the Conference Hall of CBIT:

Agenda:

- 1) To discuss about the conduct of 'SUDHEE & SRUTHI' 2021 from 3rd to 6th March 2021.
- 2) Any other related matter with the permission of the Chair.

The following members were present:

- | | |
|-----------------------------|--------------------|
| 1. Mr. J. Pratap Reddy | Chairman |
| 2. Mrs. D. Sandhya Sree | Member |
| 3. Mr. B. Saharsh Reddy | Member |
| 4. Mrs. P. Divya Reddy | Member |
| 5. Dr. G.P. Sarathi Varma | Principal |
| 6. Prof. P. Sreenivas Sarma | Director-SA&P CBIT |

The following faculties who have a key role to play in the conduct of SUDHEE and SRUTHI were also present in the meeting.

- | | |
|---|---------------------------|
| 1. Dr. N.V.Koteswara Rao, Prof, ECE | Chairman, SUDHEE-2021 |
| 2. Dr.K.Jagannadha Rao, Prof, CED - JD - SA&P | Convener SHRUTHI-2021. |
| 3. Dr.M.Koti Reddy, Prof, CED | Co-Chairman, SUDHEE-2021 |
| 4. Dr.G.Suresh Babu, Prof & Head, EEE | Co-Chairman, SUUDHEE-2021 |
| 5. Dr.Shyam Mohan Reddy, | Physical Director |
| 6. Dr. M.Trupthi, Asst Prof, IT | Co-Convener, SUDHEE-2021 |
| 7. Sri. Sreenivasulu Andoju, Asst Prof, English | Co-Convener, SHRUTHI-2021 |

1. ITEM-1:

Conduct of 'SUDHEE' and 'SHRUTHI' from 3rd to 6th March, 2021.

- a) **SUDHEE-2021:** It is resolved to conduct SUDHEE-2021 in online mode for two full days on 3rd and 4th March, 2021. Core team of SUHDDEE is advised to select a theme related to post COVID situation/Crisis management. They are further advised to put up budget proposals considering the online mode of conduct.0

Principal

**Chaitanya Bharathi Institute of Technology
(Autonomous)
Gandipet, Hyderabad-500 075.**



- b) **Sports Day Celebration:** It is resolved to permit the conduct of sports and games competitions in offline mode for limited number of events and with limited number of teams. These competitions can be spread over a month's time strictly following the COVID norms and precautions. The Prizes for the winners may be given away immediately after completing the finals in each event. However, the celebrations of sports day can be conducted 'online' on 5th March, 2021 for a period of about 2 hrs. These celebrations could include speeches by the dignitaries followed by announcements of Medal winners in various events as is done in normal practice. Physical director is advised to put up budget proposals.
- c) **SHRUTHI-2021 AND INSTITUTE DAY:** It is resolved to conduct "SHRUTHI-2021" in 'online mode' on 6th March, 2021. The Institute day celebrations may include speeches by dignitaries and announcements of medal winners for about 1hr time, followed by events of the cultural festival SHRUTHI-2021 not exceeding 2hrs. Core committee of SHRUTHI-2021 is advised to design and conduct any competitions in cultural and literary area, strictly considering COVID norms. The screening of the events for performing on the final day i.e. 6th March, 2021, can be done during the prior 1month period, giving due consideration to COVID norms. Wherever there is involvement of other college students, they are advised to find innovative and safer ways of conducting the competitions. They are further advised to put up budget proposals considering the 'Online Mode'.

2. ITEM-2:

As there were no other item to discuss, the meeting concluded with the presentation of vote of Thanks.

-s/d-

J. PRATAP REDDY
Chairman

Student Activities Advisory Committee

Principal
Chaitanya Bharathi Institute of Technology
(Autonomous)
Gandipet, Hyderabad-500 075.





CHAITANYA BHARATHI
INSTITUTE OF TECHNOLOGY (A)
Kakapeet(Village) Gandipet, Hyderabad, Telangana-500075 www.cbit.ac.in



COMMITTED TO
RESEARCH,
INNOVATION AND
EDUCATION
42
years

SUDHEE - 2021
3rd - 4th March, 2021

CORE COMMITTEE

- Advisor** : Dr. G. P. Saradhi Varma, Principal.
Chairman : Dr. N. V. Koteswara Rao, Professor, Department of ECE.
Co-Chairman : Dr. M. Koti Reddy, Professor, Department of Civil Engg.
Convener : Dr. P. Prabhakar Reddy, Professor, Dept. of Mech. Engg.
Co-Convener : Dr. M. Trupthi, Assistant Professor, Department of IT.

All the following Committee members are hereby requested to support and complete their responsibilities for making SUDHEE-2021 a grand success.

1. Publicity and Reception Committee
2. Technical Committee
3. Cyber Committee
4. Accounts & Finance Committee
5. Disciplinary Committee
6. General Maintenance Committee

M

PRINCIPAL &
Advisor, SUDHEE-2021

To the all Heads of the Departments / Head of Sections for information and with a request to arrange for circulation among the faculty and staff under their control & for N/a
To all Directors, Joint Directors, HR, CoE, Librarian & PD- for information & N/a.

Principal
Chaitanya Bharathi Institute of Technology
(Autonomous)
Gandipet, Hyderabad-500 075.



1. PUBLICITY AND RECEPTION COMMITTEE:

1	Dr. Ravindra Pogaku, Professor, Chemical -HOD & Director RLS	Advisor
2	Dr. NLN Reddy, Associate Professor, Chemical & Director CDC	Advisor
3	Dr. P.V.R. Ravindra Reddy, Professor, Mech. & HOD	Chairman
4	Dr. P. Raj Reddy, Professor, Maths & HOD	Co-Chairman
5	Dr. Yadavalli Rajasti, Associate Professor, Biotech & I/c. Head	Co-Chairman
6	Dr. M.V. Krishna Rao, Professor, CIVIL	Co-Chairman
7	Dr. N.V. Srinivasulu, Professor, Mech	Convener
8	Dr. T. Ratna Reddy, Associate Professor, Mech	Co-Convener
9	Smt. N. Ramadevi, Professor, CSE	Co-Convener
10	Dr. N. Ravi Dakshina Murthy, Associate Professor, CIVIL	Co-Convener
11	Dr. Jalaja Enamala, Associate Professor, SMS	Member
12	Dr. V. Aruna, Assistant Professor, Biotech.	Member
13	Dr. K. Raja Gopal, Assistant Professor, Biotech.	Member
14	Ms. Y. Vineetha, Assistant Professor, Biotech.	Member
15	Sri K. Prasad Babu, Assistant Professor, Chemical	Member
16	Mrs. Harsha Nagar, Assistant Professor, Chemical	Member
17	Dr. Harikrishnan. N. Assistant Professor, Chemical	Member
18	Dr. M. Mamatha, Assistant Professor, Chemistry	Member
19	Dr. Satish Kumar Kurapati, Assistant Professor, Chemistry	Member
20	Ms. T. Malleshwari Devi, Assistant Professor, CIVIL	Member
21	Sri K. V. Vivek, Assistant Professor, CIVIL	Member
22	Smt. Aswari Sultana Begum, Assistant Professor, CIVIL.	Member
23	Sri R. Swami Ranga Reddy, Assistant Professor, CIVIL	Member
24	Sri G. Vivek, Assistant Professor, CSE	Member
25	Sri Ch. V. Krishna Reddy, Assistant Professor, EEE	Member
26	Sri M. V. Nagabhushanam, Assistant Professor, ECE	Member
27	Dr. M. Ramana Reddy, Assistant Professor, ECE	Member
28	Sri N. Jagan Mohan Reddy, Assistant Professor, ECE	Member
29	Smt. N. Dhanalakshmi, Assistant Professor, ECE	Member
30	Smt. K. Suganya, Assistant Professor, IT	Member
31	Sri D. Jayaram, Assistant Professor, MCA	Member
32	Dr. B. R. Sreedhar, Assistant Professor, Maths	Member
33	Dr. G. Deepa, Assistant Professor, Maths	Member
34	Dr. K. Sharada, Assistant Professor, Maths	Member
35	Dr. A. Padma, Assistant Professor, Maths	Member
36	Dr. L. Suresh Kumar, Assistant Professor, Mech	Member
37	Sri K. Gurubrahmam, Assistant Professor, Mech	Member
38	Dr. Manowar Hussain, Assistant Professor, Mech	Member
39	Dr. Rahul, Assistant Professor, Mech	Member
40	Dr. Puneet Chandran, Assistant Professor, Mech	Member
41	Dr. Mahendra Babu Kantipudi, Assistant Professor, Mech	Member
42	Dr. Y. Srinivasa Reddy, Assistant Professor, Physics	Member
43	Dr. Santhosh Kumar. A., Assistant Professor, Physics	Member
44	Dr. M. Anil Kumar, Assistant Professor, SMS	Member
45	Smt. K. Bhagya Lakshmi, Assistant Professor, SMS	Member
46	Smt. M. Sangeetha, Assistant Professor, SMS	Member
47	Sri P. Srinivasa Reddy, Programmer, AEC	Member
48	Sri K. Venkat Reddy, Assistant Programmer, T&PO	Member
49	Sri Y. Chandrasekhar, Assistant Programmer, Mech	Member
50	Sri B. Sarat Kumar, Assistant Programmer	Member
51	Ms. U. Dharani, Computer Operator, CSE	Member

(Handwritten Signature)

Principal

**Chaitanya Bharathi Institute of Technology
(Autonomous)
Gandipet, Hyderabad-500 075.**



Responsibilities:

- i) To finalize SUDHEE-2021 e-poster from the nominations submitted by the students.
- ii) To publicize the SUDHEE-2021 event(s) in the Institute website.
- iii) To publicize the event by sending e-posters to various Institutions.
- iv) To arrange for the coverage of the event in print and electronic media.
- v) To collect photographs/snap shots of all the events of all the departments.
- vi) To prepare and distribution of e-Invitation Cards.
- vii) To arrange printing of Invitation cards and e-poster, if required.
- viii) To finalize chief guest and guest of honour for both inaugural and valedictory functions with the coordination of principal and core committee members
- ix) To prepare the program sheet for inaugural and valedictory functions
- x) To coordinate with the core committee and all other committees for any required information as per the emerging and dynamic situations.

2. TECHNICAL COMMITTEE:

1.	Dr. A.D.Sarma, Professor, ECE & Director-R&D	Advisor
2.	Dr. P.Ravinder Reddy, Professor, Mechanical	Advisor
3.	Dr. K.Krishna Veni, Professor, EEE & Director Academics	Chairman
4.	Dr. M.V.S Murali Krishna, Professor, Mech.	Co-Chairman
5.	Dr. A.Vimala, Professor, CIVIL	Co-Chairman
6.	Dr. D.Lakshmi Srinivasa Reddy, Associate Professor, Head, MCA	Co Chairman
7.	Dr. P.Narahari Sastry, Professor, ECE	Convener
8.	Dr. M.Balasubba Reddy, Associate Professor, EEE	Co-Convener
9.	Dr. R.Ravinder Reddy, Associate Professor, CSE	Co-Convener
10.	Dr. A.Supraja Reddy, Associate Professor, ECE	Co-Convener
11.	Dr. S.Solomon Raj, Associate Professor, Mech.	Member
12.	Dr. C.Nagendranatha Reddy, Assistant Professor, Biotech	Member
13.	Smt. N Lalitha Kumari, Assistant Professor, CIVIL	Member
14.	Sri P.Srinivasa Reddy, Assistant Professor, CIVIL	Member
15.	Sri R.Ranga Reddy, Assistant Professor, CIVIL	Member
16.	Sri E.Maheswar Reddy, Assistant Professor, CIVIL	Member
17.	Dr. P.Yugendar, Assistant Professor, CIVIL	Member
18.	Smt. Ch.Madhavi Sudha, Assistant Professor, CSE	Member
19.	Smt. I.Srujana, Assistant Professor, CSE	Member
20.	Smt. A.Sangeetha, Assistant Professor, CSE	Member
21.	Smt. E Kalpana, Assistant Professor, CSE	Member
22.	Smt. K.Mary Sudha Rani, Assistant Professor, CSE	Member
23.	Smt. T.Suvarna Kumari, Assistant Professor, CSE	Member
24.	Sri E.Chandrashekar, Assistant Professor, ECE	Member
25.	Sri P.Sathish, Assistant Professor, ECE	Member
26.	Dr. K.Suman, Assistant Professor, ECE	Member
27.	Sri G.Mallikarjuna Rao, Assistant Professor, ECE	Member
28.	Sri G.V.Pradeep Kumar, Assistant Professor, ECE	Member
29.	Dr. N.V.Phanendra Babu, Assistant Professor, EEE	Member
30.	Sri N.Santosh Kumar, Assistant Professor, EEE	Member
31.	Dr. Ahmed Syed, Assistant Professor, EEE	Member
32.	Mrs. P.Naga Chaitanya, Assistant Professor, EEE	Member
33.	Mrs. B.Venkata Haritha, Assistant Professor, EEE	Member
34.	Sri B. Krishna Chaitanya, Assistant Professor, EEE	Member
35.	Dr. P.Madhuri, Assistant Professor, Chemical	Member
36.	Dr. Saritha.D, Assistant Professor, Chemistry	Member
37.	Smt. Kratika Sharma, Assistant Professor, IT	Member
38.	Smt. E.Ramalakshmi, Assistant Professor, IT	Member

Principal

Chaitanya Bharathi Institute of Technology
(Autonomous)
Gandipet, Hyderabad-500 075.



39.	Smt. K.Swathi, Assistant Professor, IT	Member
40.	Dr. B.Veera Jyothi, Assistant Professor, IT	Member
41.	Sri K.Gangadhar Rao, Assistant Professor, IT	Member
42.	Ms. D.S.Madhuri, Assistant Professor, Mech	Member
43.	Smt. KNV Sreedevi, Assistant Professor, Mech	Member
44.	Sri Chintireddy Sharath Reddy, Assistant Professor, Mech	Member
45.	Sri CNVBR Sri Gowrinath, Assistant Professor, MCA	Member
46.	Sri P Krishna Prasad, Assistant Professor, MCA	Member
47.	Dr. Neelima Agarwal, Assistant Professor, Physics	Member
48.	Dr. K.Sowmya, Assistant Professor, SMS	Member
49.	Smt. B.Kavitha, Programmer, IT	Member
50.	Smt. T.S.Praveena, Programmer, MCA	Member
51.	Sri K.Ravi Kiran Reddy, Assistant Programmer, AEC	Member
52.	Smt K Srilatha, Computer Operator, CSE	Member

Responsibilities:

- To decide the format for Technical papers / Abstracts and communicate the same to all the departments.
- To formulate rubrics for evaluation of technical events and communicate the same to all the departments.
- To bring out soft copy of the Souvenir / CD of SUDHEE-2021.
- To compile and consolidate the prizes to be announced and distributed pertaining to all events of all departments .
- To compile information about all keynote sessions of each department
- To formulate modalities for technical quiz in coordination with respective departments.
- To formulate modalities for Poster Presentation/Project Models/ Mini Project/ Product Display in coordination with respective departments.
- To design E-Certificates for all the activities of SUDHEE-2021 and share the required number of certificates to the respective departments.
- To inform the list of Keynote Speakers, Jury and Prize Winners in coordination with the departments to the finance committee for arranging Honorarium and prize money respectively.
- To circulate one hardcopy of printed and bounded souvenir to each department, after the event which includes necessary information.
- To coordinate with the core committee and all other committees for any required information as per the emerging and dynamic situations.

3. CYBER COMMITTEE:

1.	Dr. Umakanth Chowdary, Professor, EEE & Director - I & J	Advisor
2.	Dr. M.Swamy Das, Professor, CSE & Joint Director, Academics	Chairman
3.	Dr. K.Lakshmi, Professor & HOD, Chemistry	Co-Chairman
4.	Dr. S.Saraswathi, Associate Professor, SMS & I/c. Head	Co-Chairman
5.	Dr. K.Radhika, Professor, IT & HOD	Convener
6.	Dr. T.Murali Krishna, Associate Professor, EEE	Co-Convener
7.	Dr. T.Sudhakar Babu, Associate Professor, EEE	Co-Convener
8.	Dr. Swatmaram, Associate Professor, Maths & Asst CoE	Co-Convener
9.	Dr. G. Vijaya Laxmi, Assistant Professor, Biotech.	Member
10.	Dr. Anitha.M, Assistant Professor, Chemical	Member
11.	Dr. M.Rama Devi, Assistant Professor, Chemistry	Member
12.	Smt. P.Vimala M Ruth, Assistant Professor, CSE	Member
13.	Sri K.Kiran Prakash, Assistant Professor, CSE	Member
14.	Smt. D.Naga Jyothi, Assistant Professor, CSE	Member
15.	Smt. S.Durga Devi, Assistant Professor, CSE	Member

Principal
Chaitanya Bharathi Institute of Technology
 (Autonomous)
 Gandipet, Hyderabad-500 075.



16.	Smt. E.Swathi, Assistant Professor, CSE	Member
17.	Smt. Isha Padhy, Assistant Professor, CSE	Member
18.	Sri M.Venkata Krishna Reddy, Assistant Professor, CSE	Member
19.	Mrs. K.Dharani Tejaswini, Assistant Professor, CSE	Member
20.	Ms. R.Madhurima, Assistant Professor, CSE	Member
21.	Sri P.Ranjith, Assistant Professor, ECE	Member
22.	Sri MD Sikandar, Assistant Professor, ECE	Member
23.	Smt. Ghata Chauhan, Assistant Professor, ECE	Member
24.	Dr. M Raj Kumar Naik, Assistant Professor, ECE	
25.	Dr. N.Vasantha Gowri, Assistant Professor, EEE	Member
26.	Sri N Santosh Kumar, Assistant Professor, EEE	Member
27.	Dr. Ahmed Syed, Assistant Professor, EEE	Member
28.	Mrs. P.Naga Chaitanya, Assistant Professor, EEE	Member
29.	Smt. I Satya Kiranmai, Assistant Professor, IT	Member
30.	Smt. Deepa.R, Assistant Professor, IT	Member
31.	Smt. B.Surya Samantha, Assistant Professor, IT	Member
32.	Sri K.Rajesh Kannan, Assistant Professor, IT	Member
33.	Sri R Govardhan Reddy, Assistant Professor, IT	Member
34.	Dr. B.Indira, Assistant Professor, MCA	Member
35.	Sri P Kiran Kumar, Assistant Professor, Mech	Member
36.	Dr. Ch.Indira Priyadarshini, Assistant Professor, Mech.	Member
37.	Dr. B.V S.Rao, Assistant Professor, Mech.	Member
38.	Smt. N.Jyothirmai, Assistant Professor, Mech.	Member
39.	Smt. P.Anjani Devi, Assistant Professor, Mech.	Member
40.	Dr. P.Rama Lakshmi, Assistant Professor, Mech.	Member
41.	Smt. Ch.V.Sushma, Assistant Professor, Mech.	Member
42.	Dr. S.Shravan Kumar Reddy, Assistant Professor, PHY	Member
43.	Dr. M Narender, Assistant Professor, SMS	Member
44.	Sri E.Sanjeeva Reddy, SPP-IA System Engineer	Member
45.	Sri B.Sangeev Kumar, Programmer, ECE	Member
46.	Sri B.Sarat Kumar, Asst. Programmer, Library	Member
47.	Sri R.Anand Raj, Asst. Programmer, CSE	Member
48.	Sri R.Navanadh, Computer Operator, CSE	Member
49.	Sri G.Venkata Kishore, Computer Operator, IT	Member
50.	Sri K.Lakshmanna, Sr. Research Asst., R & D	Member
51.	Sri K.Suresh Verma, Computer Operator, AEC	Member
52.	Sri Syed Shanawaz Basha, Computer Operator, AEC	Member

Responsibilities:

- i) To facilitate the necessary infrastructure for online platform in consultation with the respective departments.
- ii) To arrange provision in the website to post the respective department fest Links.
- iii) To create the necessary link(s) for Inaugural/ Valedictory Session.
- iv) To create the necessary link(s) for all the department level technical events.
- v) To facilitate the recording of all the online events.
- vi) To facilitate the conduct of Inaugural session, keynote lecture and valedictory sessions.
- vii) To create the necessary Google forms as requested by the respective departments.
- viii) To create registration links for the participants for their respective events of the concerned departments.
- ix) To coordinate with all departments for any other Cyber Links.
- x) To coordinate with the core committee and all other committees for any required information as per the emerging and dynamic situations.

(Handwritten Signature)

Principal

**Chaitanya Bharathi Institute of Technology
(Autonomous)
Gandipet, Hyderabad-500 075.**



4. ACCOUNTS AND FINANCE COMMITTEE : (Common to Sudhee and Shruthi)

1.	Smt. Anne Violet B, Head, Human Resources	Chairman
2.	Smt. A.V S Subadradevi, Superintendent, Administrative Office	Co-Chairman
3.	Sri J Balasubramanyam, Spl Cat. Stenographer, Human Resources	Co-Chairman
4.	Sri D. Pandu Rangam, Superintendent, Purchase	Convener
5.	Smt. Krutika Atre, Sr. Accountant, Administrative Office	Co-Convener
6.	Smt. K. Akhila Vasavi, Junior Assistant, Purchase	Co-Convener
7.	Sri T.Sudhakar Reddy, Sr.Asst.	Member
8.	Sri G.Sandeep, Junior Assistant	Member
9.	Sri S.Kirpal Singh, DTP Operator	Member
10.	Sri DVN Rathan Kumar, Sr.Asst	Member
11.	Smt. D Prasanna Goud, Asst. Programmer	Member
12.	Smt. T.Kiranmayi, Stenographer	Member
13.	Sri B.Srikanth, Computer Operator	Member
14.	Sri G.Srisailam, Junior Assistant	Member
15.	Sri G.Siddhartha Kumar, Computer Operator	Member
16.	Sri J Ravi, Junior Assistant	Member
17.	Smt. V Lavanya, Junior Assistant	Member
18.	Sri K.Nagender, Spl. Gr. Attender	Member
19.	Sri G.Srikanth Reddy, Stores Asst.	Member
20.	Sri K.Srikanth, Stores Attendant	Member
21.	Sri G.Srinivas, Sweeper/ Mali/ Watermen	Member

Responsibilities:

- i) Formulation and revealing the policies for financial transactions during Sudhee and Shruthi.
- ii) Receiving budget proposals from various sub- committees through proper channel.
- iii) Reviewing and approval of the proposals.
- iv) Financial sanctions.
- v) Purchases.
- vi) Consideration of sponsorships and approvals.
- vii) Maintaining accounts.
- viii) To consolidate the budget requirements from the respective committees and respective departments.
- ix) To arrange transfer of Honorarium to the Guest Speakers, Juries and Prize Winners in coordination with the departments.
- x) To look after the Accounting & Purchase aspects in coordination with accounts and purchase departments.
- xi) To coordinate with the core committee and all other committees for any required information as per the emerging and dynamic situations

5. DISCIPLINARY COMMITTEE:

All Directors, Joint Directors, Heads of Departments and all Professors.

Responsibilities:

- i) To look after all the Disciplinary aspects during SUDHEE-2021 event.
- ii) To coordinate with the core committee and all other committees for any required information as per the emerging and dynamic situations



Principal

Chaitanya Bharathi Institute of Technology
(Autonomous)
Gandipet, Hyderabad-500 075.



6. GENERAL MAINTENANCE COMMITTEE:

1.	Sri K.R.K. Prasad, Project Engineer	Chairman
2.	Sri S. Lakshmi pathi, Maintenance	Convener
3.	Sri P.Srinivas, Maintenance	Co-Convener
4.	Sri K.Vara Prasad, Sr. Asst., AEC	Member
5.	Sri G.Bangar Reddy, Sr. Asst., AEC	Member
6.	Smt. D.Madhavi latha, Technician, Biotech.	Member
7.	Smt. S.Kavitha, Technician, Biotech.	Member
8.	Sri M.Laxmana Chary, Technician, Chem.	Member
9.	Sri V.Sanjeeva Reddy, Technician, Chem.	Member
10.	Sri G.Mahender Reddy, Technician, Chemistry	Member
11.	Sri CH.Harinarayana Reddy, Lab Assistant, CIVIL	Member
12.	Sri K.Balaiah, Technician, CIVIL	Member
13.	Sri S.Chandra Reddy, Technician, ECE	Member
14.	Sri N.Seshagiri Rao, Technician, ECE	Member
15.	Sri N.Krishnaiah, Skilled Asst, ECE	Member
16.	Sri M.P.Radha, Technician, ECE	Member
17.	Sri K.Komaraiah, Technician, EEE	Member
18.	Sri K.Mallesh, Technician, EEE	Member
19.	Sri A.Krishnama Chary, Technician, EEE	Member
20.	Sri M.Kishore, Technician, EEE	Member
21.	Sri A.Shyamaiah CHARY, Jr. Library Asst.	Member
22.	Ms. D.Neetha, Jr. Library Asst.	Member
23.	Sri J.Pradeep Kumar, DEO as Jr.Asst (C)	Member
24.	Sri A.Nagaiah, Technician, Mech.	Member
25.	Sri M.Laxmaiah, Technician, Mech.	Member
26.	Sri E.Satayanaarayana, Technician, Mech.	Member
27.	Sri R.Kumar, Technician, Mech.	Member
28.	Sri K.Raj Gopal, Technician, Mech	Member
29.	Sri E.Ramesh, Skilled Asst, Mech.	Member
30.	Sri V.Bhaskar, Technician, Mech.	Member
31.	Sri V.Srinivas, Technician, Mech.	Member
32.	Sri S.Narasimha Reddy, Lab Assistant, Physics	Member
33.	Sri S.Siva Kumar, Technical, Physics	Member
34.	V.Jyothi, Attender/Sweeper, AEC	Member
35.	B.Praveen Kumar, Attender, AEC	Member
36.	B.Yadagiri, Attender, CIVIL	Member
37.	C.Sreenivas, Attender, ECE	Member
38.	B.Narasimha, Electrician, Maintenance	Member
39.	B.C. Pullaiah, Attender, Maintenance	Member
40.	U.Uma Rani, Attender, Maintenance	Member

Responsibilities:

- To look after the General Maintenance aspects during SUDHEE-2021 in the campus.
- To coordinate with the core committee and all other committees for any required information as per the emerging and dynamic situations

M

Principal

Chaitanya Bharathi Institute of Technology

(Autonomous)

Gandipet, Hyderabad-500 075.



QPS
**PRINCIPAL &
Advisor, SUDHEE-2021**



CHAITANYA BHARATHI
INSTITUTE OF TECHNOLOGY (A)

Kokapet(Village) Gandipet, Hyderabad, Telangana-500075 www.cbit.ac.in



COMMITTED TO
RESEARCH
INNOVATION AND
EDUCATION

42
years

SHRUTHI2021 5th & 6th March 2021

Advisor	: Dr. G P Saradhi Varma, Principal
Chairman	: Prof. P Sreenivas Sarma, Director, SA&P
Co-Chairman	: Dr. G Suresh Babu, Head, EEE
Convener	: Dr. K Jagannadha Rao, Head & Joint Director, SA&P
Co-Convener	: Sri Srinivasulu Andoju, Asst. Prof., English

All the following committee members are hereby requested to support and complete their responsibilities for making SHRUTHI-2021 a grand success.

1. Academics Committee
2. Cultural Events Committee
3. Cyber Committee
4. Disciplinary and Covid- Norms Implementation Committee
5. Finance and Purchasing Committee
6. Hospitality and Reception Committee
7. Literary Events Committee
8. Publicity Committee
9. Sport and Games Committee
10. Stage Arrangements and Programme Production Committee
11. Technical Arrangements and Programme Streaming Committee
12. Transport Committee

G.P.S.
PRINCIPAL

& Advisor, SHRUTHI-2021

To all the Directors, Joint Directors, Heads of the Departments/ Section Heads, for information and with a request to arrange for circulation among the faculty and staff under their control & for N/a To, HR, CoE, Librarian & PD- for information & N/a.

G.P.S.
1

Principal

Chaitanya Bharathi Institute of Technology
(Autonomous)
Gandipet, Hyderabad-500 075.



1. Academic Committee:

1	Dr. R Sreedhar Rao	Chairman	Director AEC&COE	9866589027
2	Dr. P Venkata Prasad	Co-Chairman	Prof. & COE, EEE	9848753742
3	Dr. V V Seshagiri Rao	Convenor	Asst. COE	9441352367
4	Dr. S Narasimha Kumar	Co-Convenor	Asst.Prof.,MED	9848349240

Members:

1	Sri I Pranav	Asst Prof.	EEE	9553311012
2	Smt. A Sathyavathi	Asst. Prof.	MED	9494235614
3	Smt. Y Nagini	Asst. Prof.	MED	9885053049
4	Dr. E Padmalatha	Asst. Prof.	CSE	9912233687
5	Smt. A Sirisha	Asst. Prof.	II	9885266048
6	Dr. C Obul Reddy	Asst. Prof.	Biotech	9989251954
7	Dr. K Vinay Kumar Reddy	Asst. Prof.	Physics	9966352545
8	Dr. M Subhadra	Asst. Prof.	Physics	9290710624
9	Sri PL NarshimaSwamy	SPP-IB Attender	CED	9032346450
10	Sri K Satyanarayana	Tech Gr-I	Chemical Engg.	7569460452
11	Sri B Maheshwar	Spl Gr. Technician Gr-III	EEE	9490317665
12	Sri K Satyanarayana	Spl Gr. Attender	Lib. & Info. Centre	7569460452
13	Sri K Laxmaiah	Spl Gr. Attender	Maint.	7859045737
14	Sri C Shani Kumar	Spl Gr. Attender	Maint.	9032568162
15	Sri G Bagaiah	Spl Gr. Attender	Maint.	
16	Sri P Anjaneyulu	Spl Gr. Attender	Maint.	9704470271
17	Sri M Srinivas	Attender	Maint.	
18	Sri K Yadaiah	SPP-IB Attender	Maths	9948587108
19	Sri G Krishna Murthy	Technician Gr-I	MED	
20	Sri K Balakrishna	Spl Gr Attender	MED	
21	Sri K Chinnaiah	SPP- IB Attender	MED	9705260591
22	Sri S Narasimha Reddy	Spl.Gr Lab Asst	Physics	9010098448
23	Sri KHVSS Phani Kumar	Technical Supervisor	Engg.Dept.	7416020727

Principal

Chaitanya Bharathi Institute of Technology

(Autonomous)

Gandipet, Hyderabad-500 075.



2. Cultural Events Committee:

1	Dr. D Krishna Reddy	Chairman	Prof & Head, ECE	9866502428 0
2	Dr. B Sreenivas Reddy	Co-Chairman	Prof., Physics	
3	Sri A Balaji Rao	Convenor	Assoc Prof, CED	9848421302
4	Dr. P Kowstubha	Co-Convenor	Assoc. Prof., EEE	9676402000

Members:

1	Smt. K Manasa	Asst. Prof.	CED	9618079892
2	Smt. Karthika Kishore Koka	Asst. Prof.	CED	8333090365
3	Sri M Thirupathaiiah	Asst. Prof.	EEE	9963181845
4	Sri J Bala Krishna	Asst. Prof.	ECE	8985151787
5	Sri D Ravi	Asst. Prof.	Mech	9030222181
6	Smt. G Vanitha	Asst. Prof.	CSE	9959959585
7	Dr. Pragathi Priyadarshinee	Asst. Prof.	IT	9676297025
8	Dr. V Swapna	Asst. Prof.	CHEM	9966840045
9	Sri G Nataraju	Asst. Prof.	Physics	9966678880
10	Sri M Kalidas	Asst. Prof.	MCA	9391264079
11	Dr. Mamatha Thakur	Asst. Prof.	MATHS	9618778184
12	Smt. B Lavanya	Asst. Prof.	SMS	9703559595
13	Smt. S Vinutha	Junior Assistant	Exam Branch	9177730365
14	Smt. Ch. Sumana	Spl. Gr. Sr. Asst	Exam Branch	8897495176
15	Smt. K Prasanna	Jr. Asst	Exam Branch	
16	Smt. TL Latithamba	Sr. Asst	AEC	9542612594
17	Smt. B BhagyaLaxmi	Technician, Gr. III	CED	9347450452
18	Smt. V Chandra Sekhar Yadav	Technician, Gr. III	ECE	
19	Sri G Siddhartha Kumar	Computer Operator	Admin. Office	93928 64907
20	Smt. P Bhavani	Jr. LibAsst	Lib & Inf. Centre	9603513542
21	Smt. K Swarupa Rani	Book Bearer	Lib & Inf. Centre	9701103039
22	Sri J Nithesh	Attender	Director Office	
23	Sri P Dasarathi	Attender-cum-Plumber	Maint.	9963193047
24	Smt. A Balamma	Spl. Gr. Attender	Maint.	
25	Smt. T Sumithra	Spl. Gr. Attender	Maint.	9010256509
26	Sri A Srikanth	Spl. Gr. Attender	Maint.	9989438329
27	Sri T Ratnakar	Attender	Maint.	8019583476
28	Sri M Devendar Reddy	Technician Gr. III	Maint.	
29	Si G Mahender Reddy	Attender	Maint.	
30	Sri K Jangaiah	Gardener	Hostel	

(Handwritten Signature)

Principal

Chaitanya Bharathi Institute of Technology

(Autonomous)

Gandipet, Hyderabad, 500 075.



3. Cyber Committee:

1	Dr. Y Ramadevi	Chairman	Prof. & HOD, CSE	9441286660
2	Dr. P V Nagaprapurna	Co-Chairman	Assoc. Prof., ChemEngg.	9885256057
3	Dr. A Vani	Convenor	Assoc. Prof., ECE	9440079310
4	Sri D Jayaram	Co- Convenor	Asst Prof., MCA	9440080590

Members:

1	Sri K Koteswara Rao	Asst.Prof	CFD	9704345297
2	Sri G Hari Krishna	Asst.Prof	EEE	9948112668
3	Smt. KSRS Jyothsna	Asst.Prof	ECE	9959540941
4	Sri A Krishna Kumar	Asst.Prof	ECE	9440431769
5	Dr. Sai Krishna Kondoju	Asst.Prof	ECE	9000285206
6	Smt. D Sony	Asst.Prof	MED	9700583344
7	Sri N Venkateshwar Rao	Asst.Prof	MED	9248161694
8	Sri K Narasimha	Asst.Prof	MED	9880992655
9	Dr. InturiVamsi	Asst Prof	MED	
10	Smt. K Spandana	Asst.Prof	CSE	8008205212
11	Sri J Shiva Sai	Asst.Prof	CSE	9700750020
12	Sri V Santosh	Asst.Prof	IT	9030012209
13	Sri Vasanth Sena	Asst.Prof	IT	9704646320
14	Sri MVN Bhaskar Rao	Comp.Op	Exam Branch	
15	Sri B Vinay Kumar	Comp.Op	CSE	
16	Smt. T Vijaya	Comp.Op	IT	
17	Sri S Rajesh	Comp.Op	CSE	
18	Sri Y Madhu	Comp.Op	CSE	
19	Smt. B Padmavathi	Spl. Gr. Comp. Op	Exam Branch	9908950918
20	Sri Surya PrakashRao	Programmer	CSE	9247578551
21	Sri P Ramesh babu	Programmer	CSE	9866637590
22	Sri V Kondal Reddy	Programmer	MCA	9441676536
23	Smt. S Vinutha	Junior Assistant	Exam Branch	9177730365
24	Sri Shaik Amir	Skilled Asst.	Biotechnology	9010795424
25	Smt. K Kalpana	Spl Gr Tech-Gr-II	IT	8897049216
26	Sri K Ramulu	Spl.Gr.Attender	Maint.	9948236802
27	Sri D Laxman	Spl.Gr.Attender	Maint	8184840132
28	Sri V Sadhanandam	Attender	Maint.	9177484745
29	Sri V Srihari	SPP- IA Attender	Physics	
30	Sri V Govardhan Reddy	Superintendent	Hostel	
31	Sri Shaik Afsar	Spl. Gr. Watchman	Hostel	
32	Sri G Sudarshan	Asst. Electrician	Hostel	



Principal

Chaitanya Bharathi Institute of Technology
(Autonomous) 4

Gandipet, Hyderabad-500 075.



4. Disciplinary and COVID Norms Implementation Committee: (Common to Sudhee and Shruthi)

All Directors, Joint Directors, Heads of Departments and all Professors.

5. Finance and Purchasing Committee: (Common to Sudhee and Shruthi):

1	Smt. Anne. Violet	Chairman	Head, HR	7702218313
2	Smt. A V S Subhadra Devi	Co-Chairman	Supdt., Admin. Office	9441421025
3	Sri J Balasubramanyam	Co- Chairman	Spl.Cat Steno, HR	9966620969
4	Sri Pandu Rangam	Convener	Superintendent, Purchase	
5	Smt. Krutika Atre	Co- Convener	Sr. Accountant, Admin. Office	
6	Smt. K Akhila Vasavi	Co- Convener	Jr. Accountant, Purchase	

Members:

1	Sri G Sandeep	Junior Asst.	HR	9849700510
2	Smt. G Vani	Front Office Executive	Exam Branch	7661075556
3	Sri D Prasanna Goud	Asst. Prog.	Admin Office	9849420798
4	Smt. T Kiranmayee	Steno	Admin Office	9248772580
5	Sri G Srisailam	Junior Asst.	Admin Office	
6	Ms. V Lavanya	Junior Asst.	Admin Office	
7	Sri G Srikanth Reddy	Stores Asst.	Purchase	
8	Sri G Srinivas	Sweeper	Mali/Waterman, Purchase	
9	Sri C Mohan Lal	SPP- IB Attender	Maint.	9704016739
10	Sri K Dasharatha	Attender	Maint.	
11	Sri S Lavakumar	Skilled Assistant	MED	9581648515

Principal

Chaitanya Bharathi Institute of Technology
(Autonomous)
Gandipet, Hyderabad-500 075.



6. Hospitality and Reception Committee:

1	Dr B Linga Reddy	Chairman	Prof & HOD, Physics	9866755375
2	Dr. T S Poorna Chandrika	Co-Chairman	Assoc.Prof., SMS	9550553725
3	Dr. N Alivelu Manga	Convenor	Assoc Prof., ECE	9491595585
4	Sri G Bhaskar Reddy	Co-Convenor	Asst. Prof., CED	9490702644

Members:

1	Sri M Kalyan	Asst.Prof.	CED	9030144407
2	Sri Ch. Harish	Asst. Prof.	EEE	9441952462
3	Sri M Anil	Asst. Prof.	EEE	8019404814
4	Sri T Sridhar	Asst. Prof.	ECE	8801206497
5	Dr. N Janardhan	Asst. Prof.	MED	9640697772
6	Sri A Mohan	Asst. Prof.	CSE	9948289684
7	Smt. B Sarada	Asst. Prof.	IT	9989678524
8	Dr. M Kalyani	Asst. Prof.	Chemical Engg.	9885308069
9	Dr. Damanjeet	Asst. Prof.	SMS	9876185378
10	Sri A Raja Sekhar	Technician Gr-I	CED	9440716764
11	Sri E Yadagiri	Technician Gr-I	ECE	9346312008
12	Sri B Nela Kumar	Book Bearer	Lib. & Info. Centre	8019548911
13	Sri R Venkatesham	Book Bearer	Lib. & Info. Centre	9010554065
14	Sri P Praveen Kumar	Attender	Exam Brach	
15	Sri G Raju	Spl.Gr. Attender	Chemical Engg	9912445844
16	Smt. P Sujatha	Spl.Gr. Attender	Maint.	9640487556
17	Sri E Gopal	Spl.Gr. Attender	Maint.	9553258898
18	Sri T Narsintha	Attender	Maint.	
19	Sri G Gandaiah	Attender	Maint.	
20	Sri M Manikyam	Attender	Maint.	
21	Sri G Narsimlu	Attender	Maint.	9949303676
22	Sri D Suresh	Attender	Maint.	9912851349
23	Sri V Lingaiah	SPP-IB Attender	SMS	9966321731
24	Sri D Ramana Reddy	Supervisor	Engg. Dept	
25	Sri D Sudhakar	Attender	Engg. Dept	

(Handwritten Signature)



Principal
Chaitanya Bharathi Institute of Technology
(Autonomous)
Gandipet, Hyderabad-500 075.

7. Literary Events Committee:

1	Dr. G Chandra Mohan Reddy	Chairman	Prof , MED	9392493845
2	Sri B Suryanarayana	Co- Chairman	Assoc. Prof. MED	9441959924
3	Smt. A Vijayalakshmi	Convenor	Asst. Prof., English	9849533161
4	Sri K Naveen Kumar	Co-Convenor	Asst. Prof., English	9440944186

Members:

1	Ms. Aparna MR	Asst.Prof	CED	
2	Ms M Deepthi	Asst.Prof	EEE	
3	Smt. Ch .Navitha	Asst.Prof	ECE	9966552000
4	Smt. Ipshita Mohanty	Asst Prof	MED	
5	Smt. Kavita Agarwal	Asst. Prof	CSE	9704305615
6	Smt. NVS Sridevi Kella	Asst. Prof.	IT	9985135993
7	Dr. S Shylaja	Asst. Prof.	Biotechnology	9885493139
8	Dr. Palle Kiran	Asst Prof	Mathematics	9573273272
9	Dr. Shagufta Parween	Asst Prof.	English	9550315302
10	Dr. Shirisha Deshpande	Asst Prof	English	9866008345
11	Sri Vare Laxman	Asst. Prof.	English	8331816207
12	Sri A Krishna Reddy	Programmer	Exam Branch	9949677556
13	Sri Ellesh	Attender	Biotech	9966737393
14	Smt. A Dakshyani	Technician Gr-III	CED	8008254718
15	Sri P Venumadhava Chary	Spl Gr Tech Gr-III	EEE	9000607685
16	Sri M Ramachandra Reddy	Spl.Gr Jr.Asst	Lib. & Info. Centre	9948858885
17	Sri A Shyamaiah Chary	Jr. Library Asst.	Lib. & Info. Centre	9912398185
18	Smt. D Neetha	Jr. Library Asst.	Lib. & Info. Centre	9949162113
19	Sri V Shiva Kumar	Skilled Asst	ECE	9666604890
20	Smt. M Savitri	SPP-IB Attender	Maint.	9949364685
21	Sri B Kumar	Attender	Maint.	
22	Smt. K Vijaya Kumar	Sweeper/ Mali/ Watermen	Maint.	
23	Sri E Ramachander	Technician Gr-III	MED	9951689991
24	Sri E Ravinder	SPP-IB Attender	R&D	9912374268
25	Sri A Narasimha	Spl.Gr.Watchman	Hostel	

(Handwritten Signature)



Principal
Chaitanya Bharathi Institute of Technology
(Autonomous)
Gandipet, Hyderabad-500 075.

8. Publicity Committee:

1	Prof. SSV Chalam	Chairman	Prof., CED	9848050528
2	Dr. C Srikanth Reddy	Co-Chairman	Librarian	8466997215
3	Dr. B Suresh Kumar	Convenor	Assoc. Prof., EEE	9849396814
4	Dr. Sangeeta Gupta	Co-Convenor	Assoc. Prof., CSE	9989404702

Members:

1	Sri D Sathish	Asst. Prof	EEE	9492433934
2	Smt. B Neeraja	Asst. Prof.	ECE	9966040466
3	Sri Suraj Prakash Sahoo	Asst. Prof	ECE	
4	Sri T N Aditya	Asst. Prof.	MED	9985868153
5	Smt. G Shanmukhi Rama	Asst. Prof.	CSE	9949438284
6	Smt. B Swathi Sowmya	Asst. Prof.	IT	9494568008
7	Smt. Y Gnyana Deep	Asst. Prof.	IT	9000399729
8	Dr. B Ganesh	Asst. Prof.	Chemical Engg	9701443474
9	Dr. GNR Prasad	Asst. Prof.	MCA	9885191683
10	Dr. Paruthi Mandakini	Asst. Prof.	SMS	9493048650
11	Dr. G Venkata Ramesh	Asst. Prof.	Chemistry	807690906
12	Smt. D Hemalatha	Sr.Asst	Exam Branch	8008894282
13	Sri B Sekhar	Comp. Operator	Biotech	9908479789
14	Sri B Venkataiah	Spl. Gr. Record Asst.	Chemistry	7659006744
15	Sri VijayaBhaskar	Lab Asst	EEE	9247229804
16	Sri Krishna Vallabhaneni	Technician Gr-III	EEE	
17	Sri N Shankaraiah	SPP-IB Attender	Lib. & Info. Centre	9912881441
18	Sri B Ramulu	SPP-IB Attender	Lib. & Info. Centre	9705490855
19	Sri T Pochaiiah	Attender	Maint.	
20	Sri C P Narayana	Attender	Maint.	7095434025
21	Sri A Mallesh	Spl. Gr. Attender	Maint.	9542889391
22	Sri R Satish	Attender	Maint.	9959800865
23	Sri N Chandrashekar	Technician Gr-III	MED	86861833539
24	Sri T Mallesh	Technician-III	MED	9247339759
25	Sri V Srihari	SPP-IA Attender	Physics	

(Handwritten Signature)

Principal

**Chaitanya Bharathi Institute of Technology
(Autonomous)
Gandipet, Hyderabad-500 075.**



9. Sports and Games Committee:

1	Dr. G Shyam Mohan Reddy	Chairman	Physical Director	8466997219
2	Dr. Sadasiva Rao	Co-Chairman	Prof., MCA	9618755989
3	Dr. R Rajeshwari	Convenor	Asst. Physical Director	9866706855
4	Sri I Balakrishna	Co-Convenor	Asst. Prof., Chemical Engg.	9440450622

Members:

1	Sri K V Vivek	Asst. Prof.	CED	9666313863
2	Sri P Hemeshwar Chary	Asst. Prof.	EEE	9000234560
3	Sri P Chandrasekhar	Asst. Prof.	ECE	9395161120
4	Ms. J Mounika	Asst. Prof.	ECE	8885679221
5	Sri A Chandrakanth	Asst. Prof.	MED	8885581855
6	Sri P Surendar Reddy	Asst. Prof.	MED	9573328222
7	Sri B Ramana Reddy	Asst. Prof.	CSE	9441441810
8	Smt. Poonguzhar Selvi	Asst. Prof.	CSE	9092442647
9	Sri U Sai Ram	Asst. Prof.	CSE	8113361133
10	Smt. A Priyanka	Asst. Prof.	Biotech	9030993066
11	Dr. P Suresh	Asst. Prof.	Mathematics	9848732537
12	Sri T Ramesh	Record Asst	Exam Branch	9908423426
13	Sri D MahaboobBasha	Technician Gr-II	Biotech	9885875810
14	Sri V Rajender Reddy	Technician Gr-I	ECE	9299304533
15	Sri Sangem Srinivas	Technician Gr-II	EEE	
16	Sri B Santi Jayakar	Tech Gr-III	Chemistry	
17	Sri TSKHL.Vara Prasad,	Jr.LibAsst	Lib. & Info. Centre	9848070099
18	Smt. R Anitha	Attender	Attender	9032423733
19	Sri M Mallesh	Spl.Gr.Attender	Maint.	8897046279
20	Sri K Gandaiah	SPP- II Watchman	Maint.	000160669
21	Sri G SravanBabu	Attender	Maint.	9885959133
22	Sri Md. Abdul Gani	Spl.Gr.Attender	Maint.	9030802946
23	Sri B Lakshmaiah	Spl. Gr. Attender	Maint.	9948485887
24	Sri T SadasivaRao	Skilled Asst	MED	9985872812
25	Sri N Vitalaiah	SPP- IA Attender		
26	Smt. A Padma	Attender	Physical Education	

(Handwritten Signature)

Principal
Chaitanya Bharathi Institute of Technology
(Autonomous)
Gandipet, Hyderabad-500 075.



10. Stage Arrangements and Program Production Committee:

1	Dr. S. China Ramu	Chairman	Prof., CSE	9059991788
2	Dr. Md. Aleem Pasha	Co-Chairman	Assoc. Prof, MED	8688955412
3	Sri KRK Prasad	Convenor	Project Engg., Engg. Dept.	9848249469
4	Sri K Sudarshan Reddy	Co-Convenor	Asst. Prof., ECE	9291522525

Members:

1	Sri T Vasu Deva Rao	Asst. Prof.	CED	9849501426
2	Sri C Srisailam	Asst. Prof.	EEE	9032838993
3	Smt. Venkata Sireesha	Asst. Prof.	ECE	9951053835
4	Smt. V Sandhya	Asst. Prof.	MED	9701540189
5	Sri Yashoda Sreeram	Asst. Prof.	MED	9440424518
6	Smt. G Kavitha	Asst. Prof.	MED	9885117207
7	Sri S Rakesh	Asst. Prof.	IT	9951397356
8	Smt. S Sumitra	Asst. Prof.	Biotech	9963710844
9	Dr. P Murli Krishna	Asst. Prof.	Chemistry	9908385150
10	Sri S Tulasi Ram	Asst. Prof.	SMS	9704888306
11	Sri M Shipley	Technician Gr-II	Chemical	
12	Smt. K Vasantha Laxmi	SPP-IB Lab Asst	CED	8443233248
13	Smt. K Andalu	Spl. Gr. Attender	CSE	
14	Sri V Yadagiri	Programmer	ECE	9949904490
15	Sri M Krishna	Technician-II	ECE	9246535517
16	Sri B Yadaiah	Technician Gr-III	ECE	
17	Smt S Laxmipathi	Spl. Gr. Technician Gr-I	Maint.	9908513353
18	Sri B Narayana	Attender	Maint.	
19	Smt. M Anasuya	Attender	Maint.	
20	Smt. A Rajini	Spl.Gr.Attender	Maint.	9849935060
21	Smt. Ch. Shoba	Sweeper/Mali/Waterman	Maint.	
22	Sri V Lingaiah	SPP- IB Attender	SMS	9966321731
23	Smt. B Vani	Assistant Engineer	Engg. Dept.	

(Handwritten Signature)

Principal
Chaitanya Bharathi Institute of Technology
(Autonomous)
Gandipet, Hyderabad-500 075.



11. Technical Arrangements and Programme Streaming Committee:

1	Dr. P Suresh	Chairman	Prof. & Director, IQAC	9885313161
2	Dr. K Sagar	Co-Chairman	Prof., CSE	9849400136
3	Dr. T Sridevi	Convener	Assoc. Prof , CSE	9703406001
4	Dr. M Venugopal Chary	Co-Convener	Assoc. Prof . IT	9966199834

Members:

1	Sri M. Nagaraju	Asst. Prof.	EEE	7013526685
2	Sri T Aravinda Babu	Asst. Prof.	ECE	9908898845
3	Sri Md. Ziauddin Jahangir	Asst. Prof.	ECE	9885717845
4	Smt. Ch. Vijaya Lakshmi	Asst. Prof.	CSE	8897404405
5	Sri R Srikanth	Asst. Prof.	CSE	8078259394
6	Smt. T Prathima	Asst. Prof.	CSE	9441044722
7	Dr. K Vinay Kumar Reddy	Asst. Prof.	Physics	9966352545
8	Dr. K Ramesh	Asst. Prof.	Chemistry	9849116946
9	Sri CNVBR Gowrinath	Asst. Prof.	MCA	9491116158
10	Sri G Kotibabu	Spl Gr. Comp. Op	CSE	9666992822
11	Sri K Madhu	Comp. Op.	CoE	8309217415
12	Sri T Venkateshwarlu	Asst. Programm	CEI	9985841833
13	Smt. M Nagajyothi	Programm	CSE	9963976569
14	Sri J Ramesh Babu	Asst. Prog	EEE	9848486438
15	Smt. K Madhavi	SPP-IA Prog	IT	9490213404
16	Sri Y Ramakrishna Reddy	Gr.I.Technician	Mech	9703178099
17	Sri A Srikanth	Gr II(Technician	Mech	9989438329
18	Sri K Chandra Sekhar	SPP- IA Record Asst.	Chemistry	9948725425
19	Sri M Ramesh	Attender/ Sweeper	Maint	9866637590
20	Sri G Suresh	Attender	Maint.	9912371277
21	Sri B Srinivas Rao	Attender	Maint.	9291226066
22	Sri T Mallesh	Attender	Maint.	
23	Smt. M Vijaya Chandra Rao	Record Asst.	SMS	9912547375

(Handwritten Signature)

Principal

**Chaitanya Bharathi Institute of Technology
(Autonomous)
Gandipet, Hyderabad-500 075.**



12. Transport Committee:

1	Dr. G Laxmaiah	Chairman	Prof., MED	9849959218
2	Dr. R P Chowdary	Co-Chairman	Assoc. Prof., MED	9177220635
3	Dr. K Kishor	Convenor	Assoc. Prof., MED	9492063710
4	Sri V Balaji Kesava Rao	Co-Convenor	Asst. Prof. of Practice, SMS	8639843404

Members:

1	Sri SaiTeja Volla	Asst. Prof.	CED	95733 03463
2	Sri Chintaiiah N	Asst. Prof.	ECE	
3	Sri B Satcesh	Asst. Prof.	ECE	9866801591
4	Smt. G Manatha	Asst. Prof.	CSE	9491870706
5	Dr. Pragya Mishra	Asst. Prof.	CSE	7753058903
6	Smt. A Shalini	Asst. Prof.	Chemical Engg	9640461289
7	Sri M Amarnath	Asst. Prof.	Mathematics	9866197869
8	Sri P Vara Prasad Goud	Asst. Prof.	SMS	8106302161
9	Sri S Sateesh Reddy	Vehicle Sup	Admin office	9908176475
10	Sri K Lakshma Reddy	SPP- IA Attender	Lib. & Info Centre	9000435801
11	Sri K Mallesh	Attender	Maint.	9948837135
12	Smt. M Sunitha	Record Assistant	English	8978899623
13	Sri D Rajender Reddy	Spl.Gr. HV-Driver	Transport	9666526009
14	Sri A Mohan	Spl.Gr. HV-Driver	Transport	9885575656
15	Sri A Jagan Mohan	HV-Driver	Transport	9849812267
16	Sri K Chandraiah	HV-Driver	Transport	9908529850
17	Sri V Srinivas	HV-Driver	Transport	9966261646
18	Sri D Venkatesh Goud	HV-Driver	Transport	9985887205
19	Sri V Ravinder Naik	HV-Driver	Transport	
20	Sri D Ravi	HV-Driver	Transport	
21	Sri NP Raj	HV-Driver	Transport	
22	Sri P Dharmapuri	Watchman/ Attender	Engg. Dept.	

QPS
PRINCIPAL

& ADVISOR, SIIRUTIII 2021

Encl: Roles and Responsibilities.

QPS
Principal

Chaitanya Bharathi Institute of Technology
(Autonomous)
Gandipet, Hyderabad-500 075.





CHAITANYA BHARATHI
INSTITUTE OF TECHNOLOGY (A)
Kokapet(Village), Gandipet, Hyderabad, Telangana 500075. www.cbit.ac.in



COMMITTED TO
RESEARCH
INNOVATION AND
EDUCATION

42
years

SHRUTHI- 2021

5th and 6th March 2021

Roles and responsibility of various committees

I). Academic Committee:

1. To prepare and announce the list of CR's.
2. To prepare and announce the list of medal winners.
3. To communicate to the medal winning students and their parents.
4. To present a brief report on the academic achievements, awards and make the necessary announcements.
5. To coordinate with the core committee and any other committee for any other requirements and necessary steps as per the emerging and dynamic situation.
6. To propose budget for their committee and maintain account of expenditure incurred.

II). Cultural Events Committee:

1. To plan, schedule and organise the cultural activities, competitions and events following the COVID-19 norms.
2. To propose budget and maintain the accounts of expenditure incurred.
3. To co-ordinate with the core committee and any other committee for any other requirements and necessary steps as per the emerging and dynamic situation.

Principal

Chaitanya Bharathi Institute of Technology
(Autonomous)

Gandipet, Hyderabad-500 075.



III). Cyber Committee:

1. To facilitate the necessary infrastructure for online platform, in consultation with the other committees.
2. To create necessary links for the activities and events of cultural, literary and sports & games in consultation with the respective committees.
3. To create links for the two days of SHRUTHI- 2021 events i.e., on 5th and 6th March 2021, in consultation with technical and core committees.
4. To coordinate with all other committees for any other cyber links.
5. To look after the cyber security aspects, for the smooth conduct of various events.
6. To co-ordinate with the core committee and any other committee for any other requirements and necessary steps as per the emerging and dynamic situation.

IV). Discipline and COVID-19 Norms Implementation Committee:

1. To look after the disciplinary aspects during SUDHEE and SHRUTHI- 2021.
2. To see that the COVID-19 norms are implemented during the preparatory activities and during the conduct of SUDHEE & SHRUTHI- 2021 (i.e 3rd to 6th March 2021)
3. To put up budget proposal (if any).

V). Finance, Purchase and Accounts Committee:

1. Formulating and revealing the policies for financial transactions during SUDHEE and SHRUTHI 2021.
2. Consolidating and reviewing budget proposals from various committees received through proper channel.
3. Reviewing and approval of proposals.
4. Financial sanctions and purchases.
5. Considerations of sponsorship and approvals.

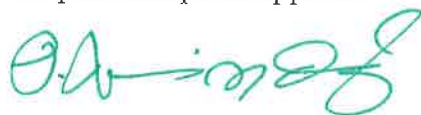

Principal

**Chaitanya Bharathi Institute of Technology
(Autonomous)
Gandipet, Hyderabad-500 075.**



6. To arrange for the transfer of Honorariums and cash prizes, as per the requests of cultural, literary and sports committees, within the sanctioned budgets.
7. To look after the accounting and purchase aspects, in coordination with accounts and purchase departments.
8. To co-ordinate with the core committee and any other committee for any other requirements and necessary steps as per the emerging and dynamic situation.

VI). Hospitality and Reception Committee:

1. To extend Hospitality to the dignitaries, trainees, organisers and performers, (those who may stay beyond college hours in the campus) during or before SHRUTHI-2021 festival, in connection with the cultural, literary and sports & games activities.
2. To receive and honour the dignitaries (in consultation with core committee) who may visit the campus during or before the SHRUTHI-2021 festival, in connection with the cultural, literary and sports & games activities.
3. To maintain an account of registrations done for various events (cultural, literary and sport & games) and submit to the core committee.
4. To make the necessary announcements of various events in the campus.
5. To put up budget proposals.
6. To co-ordinate with the core committee and any other committee for any other requirements and necessary steps as per the emerging and dynamic situation.

VII). Literary Events Committee:

1. To plan, schedule and organise literary events for SHRUTHI-2021.
2. To put up budget proposals for approval.
3. To maintain accounts of expenditure.

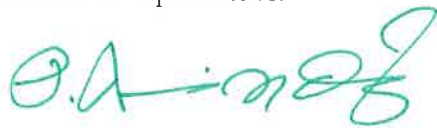

Principal
Chaitanya Bharathi Institute of Technology
(Autonomous)
Gandipet, Hyderabad-500 075.

4. To co-ordinate with the core committee and any other committee for any other requirements and necessary steps as per the emerging and dynamic situation.

VIII). Publicity Committee:

1. To publicize the main event and all the preliminary events connected to SHRUTHI- 2021.
2. To communicate to all important dignitaries/ officers/ persons about SHRUTHI- 2021, in consultation with core committee.
3. To propose innovative methods of publicity, keeping in view the online mode of conduct of SHRUTHI- 2021.
4. To make provisions from time to time, to publicize the main and preliminary events of SHRUTHI- 2021 in the website of CBIT, in coordination with the web committee of CBIT.
5. To put up budget proposals.
6. To co-ordinate with the core committee and any other committee for any other requirements and necessary steps as per the emerging and dynamic situation.

IX). Sports & Games Committee:

1. To plan, schedule and organise sports & games activities, competitions and events, strictly following COVID-19 norms.
2. To organise sports day celebrations online, on 05-03-2021.
3. To make necessary arrangements for the conduct of sports and games events.
4. To put up budget proposals.
5. To co-ordinate with the core committee and any other committee for any other requirements and necessary steps as per the emerging and dynamic situation.



Principal

**Chaitanya Bharathi Institute of Technology
(Autonomous)**

Gandipet, Hyderabad-500 075.



X). Stage arrangements and programme production committee:

1. To make all the necessary stage arrangements to organise sports day and institute day (cultural Festival) of SHRUTHI- 2021 on 5th& 6th March 2021, respectively.
2. To make limited seating arrangements in front of the stage to facilitate seating of a limited crowd (organisers, performer, trainers etc.),in compliance with the Covid-19 norms.
3. To take the inputs from cultural, literary and sports& games committees for making stage arrangements and any other necessary infrastructural arrangement.
4. To make all the necessary arrangements for producing the overall programmes on 5th and 6th March 2021 i.e. sports day and cultural festival (institute day), including Audio, Visual and Computer arrangements, in consultation with technical committee.
5. To take care of general maintenance aspects.
6. To put up budget proposals in consultation with relevant committees and keeping in view their requirement
7. To co-ordinate with the core committee and any other committee for any other requirements and necessary steps as per the emerging and dynamic situation.

XI). Technical Arrangements and Programme Streaming Committee:

1. To take all the care, make arrangements and take responsibility for effective and qualitative online streaming of total programme on 5th and 6th March 2021.
2. To make mock trials and come up with a fool proof mechanism for the live streaming of the programmes on 5th and 6th March 2021.
3. To make arrangements and take responsibility for live streaming of few identified popular events / competitions during or before SHRUTHI- 2021, in consultation with cultural, literary and sports & games committees.
4. To put up budget proposals.

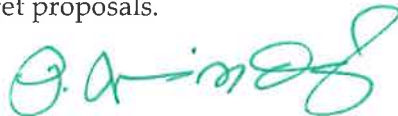

Principal
Chaitanya Bharathi Institute of Technology
(Autonomous)
Gandipet, Hyderabad-500 075.

5. To co-ordinate with the core committee and any other committee for any other requirements and necessary steps as per the emerging and dynamic situation.

XII).Transport Committee:

1. To make the required transport arrangements for the identified dignitaries/ trainers/ performers during or before SHRUTHI- 2021, in consultation with the core committee.
2. To put up budget proposals.
3. To co-ordinate with the core committee and any other committee for any other requirements and necessary steps as per the emerging and dynamic situation.

A. Anand



Principal
Chaitanya Bharathi Institute of Technology
(Autonomous)
Gandipet, Hyderabad-500 077

Minutes of the Meeting with the Directors, Joint Directors, Heads of the Departments, Heads of Sections and the Core Committees for Sudhee & Shruthi-2021 held on 01st March, 2021 at 11:15 AM in the Conference Hall.

Members Present:

1. Dr. G. P. Saradhi Varma, Principal
2. Dr. K. Krishnaveni, Director-Academics
3. Prof. P. Sreenivasa Sarma, Director-SA&P & Chairman, SHRUTHI-2021
4. Dr. A. D. Sarma, Director-R&D
5. Dr. R. Sreedhar Rao, Director-AEC
6. Dr. Ravindra Pogaku, Director-RLS & Head, Chem. Engg.
7. Dr. N. L. N. Reddy, Director-CDC
8. Dr. K. Jagannadha Rao, Joint Director-SA&P & Co-Chairman-SHRUTHI-2021
9. Dr. M. Swamy Das, Joint Director-Academics (Informatics)
10. Dr. Y. Rajasri, Head, Dept. of Biotechnology
11. Dr. K. Lakshmi, Prof. & Head, Dept. of Chemistry
12. Dr. Y. Rama Devi, Prof. & Head, Dept. of CSE
13. Dr. G. Suresh Babu, Prof. & Head, Dept. of EEE
14. Dr. P. V. R. Ravindra Reddy, Prof. & Head, Dept. of Mech. Engg.
15. Dr. B. Linga Reddy, Prof. & Head, Dept. of Physics
16. Dr. D. L. Sreenivasa Reddy, Head, Dept. of MCA
17. Dr. S. Saraswathi, Head, Dept. of SMS
18. Dr. N. V. Koteswara Rao, Chairman, SUDHEE-2021
19. Dr. P. Prabhakar Reddy, Co-Chairman, SUDHEE-2021
20. Dr. M. Koti Reddy, Convenor, SUDHEE-2021
21. Dr. M. Trupti, Co-Convenor, SUDHEE-2021
22. Dr. Swatmaram, Assoc. Prof., Dept. of Mathematics
23. Dr. K. Sugamya, Asst. Prof., Dept. of IT

Principal chaired the Session and conducted the Proceedings.

Item No.1 : Arrangements for SUDHEE & SHRUTHI-2021

Minutes : Principal informed about the Chief Guests & Guests of Honors for SUDHEE & SHRUTHI-2021 and informed that the SUDHEE Inaugural Session will be held on virtual mode and common for all the Departments and the Valedictory sessions will be held at the Department level only. In this connection, Principal asked the Chairmen, SUDHEE & SHRUTHI-2021 to brief about the arrangements made in view of the Annual Techno, Sports and Cultural Fest, 2021.

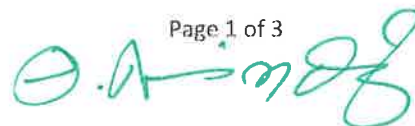

Principal

**Chaitanya Bharathi Institute of Technology
(Autonomous)
Gandipet, Hyderabad-500 075.**

The Chairman, SUDHEE-2021 briefed about the arrangements made in connection with SUDHEE-2021 and he requested the Heads of the Departments to submit Budget proposals to the Accounts Section immediately, who have not yet submitted the same. The proposal for miscellaneous expenditure shall be sent to the Accounts Section.

Further, he requested all Heads of the Departments to submit the Name, Bank Account Number and IFSC Code to the Accounts Section for the Students who got first and second prizes.

The Links for joining the Inaugural Session will be sent to all Heads of the Departments and requested to disseminate the information among all the Faculty and Students under their control.

He requested to inform all the Departmental Co-ordinators for SUDHEE-2021 to highlight the THEME for this year in every aspect they are working. Further, he requested the Director-CDC to send the Invitations to all the Stakeholders and Industry Officials.

The Chairman, SHRUTHI-2021 informed about the Chief Guest and Guests of Honors for the Event which will be held on 06.03.2021. The event will be organised both online and offline mode.

The attendance for the Students shall be taken care of the concerned Heads of the Departments from 3rd March to 6th March, 2021 and the Students have to log on to the LMS Portal on both the Sessions in the given timings. In this regard, a Circular will be issued.

As the First Saturday of March, i.e., 6th March is a working day in view of SHRUTHI-2021, it is decided to declare holiday on 13th March, 2021. In this connection, a Circular will be issued.

It is decided that the snacks will be provided to all the Staff who are staying back on 06.03.2021 and it is mandatory for all the Staff to stay back on that day till the end of the function. Staff Buses in all the 8 regular routs will ply on 06.03.2021 after the function. Seating arrangements for 600 people will be provided near the Open Air Auditorium on 06.03.2021.

It is resolved that the Semester End Examinations for the I Semester Students, Examinations will be conducted in offline mode only.

Principal advised the I year Incharge to take care of the online Feedback from the I Year Students.

It is decided to postpone the offline Class Work for all the Years, which is scheduled to be held from 08.03.2021, due to Covid Scenario. The decision in this regard will be taken based on the circumstances.

Page 2 of 3

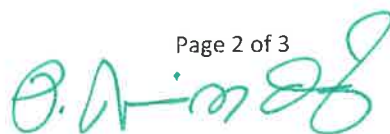

Principal
Chaitanya Bharathi Institute of Technology
(Autonomous)
Gandipet, Hyderabad-500 075.

Dr. N. V. Koteswara Rao, Chairman, NBA Institute Level Committee, requested all the Heads of the Departments to submit the Pre-qualifiers of their Department on or before Saturday. In this connection, he further requested the Director-AEC to share the Part-A of the Prequalifiers information with all the Heads of the Departments.

The Meeting is concluded with vote of thanks to the Chair.

-s/d-

PRINCIPAL

To

All Heads of the Departments, for information.

All the Directors, Joint Directors, Head-HR, CoE, for information.

Attestations by Principal



Principal

Chaitanya Bharathi Institute of Technology

(Autonomous)

Gandipet, Hyderabad-500 075.



The Management, Principal, Staff and Students of
CHAITANYA BHARATHI INSTITUTE OF TECHNOLOGY(A)

Affiliated to Osmania University, Hyderabad
UG Programmes are Accredited by NBA, Accredited by NAAC-UGC with 'A' Grade
An ISO 9001:2015 Certified Institution

Cordially invite you to grace the
INAUGURAL FUNCTION
of
SUDHEE-2021

National Level Students' Technical Fest

On Wednesday, 3rd March 2021 at 10.30 AM
Venue : through on line

Prof. R.Hariharan

Advisor-II, Approval Bureau

All India Council for Technical Education, New Delhi
has kindly consented to be the Chief Guest

Sri. E.S.Chakravarthy

Global RMG Head & Vice President

Tata Consultancy Services, Bengaluru

has kindly consented to be the Guest of Honour

'Kavi Kireeti' Dr. V. Malakonda Reddy

President, CBIT

will preside over the function

Prof. N.V.Koteswara Rao
Chairman, Sudhee-2021

Prof. G.P.S. Varma
Principal & Advisor, Sudhee-2021

P. Anand



Principal

Chaitanya Bharathi Institute of Technology

(Autonomous)

Gandipet, Hyderabad-500 075.

PROGRAMME

- 10:30 AM *Invocation*
- 10:35 AM *Welcome Address by*
Prof. G.P.S. Varma
Principal & Advisor, *SUDHEE-2021*
- 10:45 AM *About **SUDHEE-2021** by*
Prof. N.V.Koteswara Rao
Chairman, *SUDHEE-2021*
- 10:50AM *Address by*
Sri. E.S.Chakravarthy
Guest of Honour
- 11:05 AM *Address by*
Prof. R.Hariharan
Chief Guest
- 11:20 AM *Presidential address by*
'Kavi Kireeti' Dr. V. Malakonda Reddy
- 11:30 AM *Vote of thanks by*
Prof. P.Prabhakar Reddy
Convenor, *SUDHEE-2021*

-oOo-

Principal

Chaitanya Bharathi Institute of Technology
(Autonomous)
Gandipet, Hyderabad-500 075.





CHAITANYA BHARATHI
INSTITUTE OF TECHNOLOGY
Kokapet (Village), Gandipet, Hyderabad, Telangana-500075 www.cbit.ac In



NBA



MAAC

nirf

ISO Certified
9001:2015

COMMITTED TO
RESEARCH
INNOVATION AND
EDUCATION

42
years

INVITATION

Your gracious presence is solicited
on the occasion of

SHRUTHI-2021

(Online Celebration of Sports Day)

On Saturday, 5th March 2021 at 3:30 PM

Venue : Assembly Hall, CBIT(A)

Sri B.A. Ravi Kumar

International Volley Ball player (1990-93)
has graciously consented to be the Chief Guest

“KAVI KIREETI” **Dr. V MALAKONDA REDDY**

President, CBIT
has kindly consented to preside

Dr. G PARDHA SARADHI VARMA

Principal, CBIT, & Advisor, SHRUTHI – 2021
Will address the gathering

Sri. SOUDARTHI KOUSTUBH
President
Students' Association

Prof. P SREENIVAS SARMA
Director, SA&P and Chairman
SHRUTHI- 2021

Principal

Chaitanya Bharathi Institute of Technology
(Autonomous)
Gandipet, Hyderabad-500 075.



PROGRAMME

3:00 pm	Cultural Programme
3:30 PM	Lighting the Lamp and Invocation
3:35 PM	About SHRUTHI-2021 Sports Day Ms. Balidi Akshitha , EEE-1 VII Semester, Vice-President, Students' Association
3:40 PM	Report on Sports activities by Dr. G. Shyam Mohan Reddy, Physical Director
3:50 PM	Introduction of Chief Guest by Dr. G. Suresh Babu, Head- EEE, Co-Chairman, SHRUTHI - 2021
4:15 PM	Address by Dr. G. Pardha Saradhi Varma, Principal, CBIT
4:25 PM	Presidential Address by "Kavi Kireeti" Dr. V. Malakonda Reddy, President, CBIT
4:35 PM	Address by Sri B.A. Ravi Kumar, Chief Guest
4:40 PM	Prize distribution announcement of sports and Games' for shruthi-2021 Bharatha Simha Reddy, Student President – Chaitanya Kreeda
	Vote of thanks by Ms. Viswanathula Meghana, IT-1, VII Semester, Vice – President, Shruthi- 2021

Note: Link for online viewing of the programme is available on institute website
<http://www.cbit.ac.in>

Principal

Chaitanya Bharathi Institute of Technology

(Autonomous)

Gandipet, Hyderabad-500 075.





CHAITANYA BHARATHI
INSTITUTE OF TECHNOLOGY (A)
Kokapet | Village: Gandipet | Hyderabad, Telangana-500075. www.cbit.ac.in



COMMITTED TO
RESEARCH
INNOVATION AND
EDUCATION

42
years

INVITATION

Your gracious presence is solicited
on the occasion of

SHRUTHI-2021

(Online Celebration of Institute Day)

On Saturday, 6th March 2021 at 4:30 PM
Venue : Open Air Auditorium, CBIT(A)

Dr. N. V. RAMANA RAO

Director, NIT, Warangal, TS
has graciously consented to be the Chief Guest

Sri. ABBURI RAVI

Story & Screen Play Writer, Indian Cinema
has kindly consented to be the Guest of Honour

Sri. ALLARI NARESH

Indian Cinema Hero
has kindly consented to be the Guest of Honour

“KAVI KIREETI” Dr. V MALAKONDA REDDY

President, CBIT
has kindly consented to preside

Dr. G PARDHA SARADHI VARMA

Principal, CBIT, & Advisor, SHRUTHI – 2021
will present the institute report

Sri. SOUDARTHI Koustubh
President
Students' Association

Prof. P SREENIVAS SARMA
Director, SA&P and Chairman
SHRUTHI- 2021

Principal

Chaitanya Bharathi Institute of Technology
(Autonomous)
Gandipet, Hyderabad-500 075.



PROGRAMME

4:30 PM	Lighting the Lamp and Invocation
4:35 PM	Report on student activities by Mr. Soudartha Koustubh, Student President
4:40 PM	About SHRUTHI-21 and introduction of Guests by Prof. P. Sreenivas Sarma, Chairman SHRUTHI - 2021
4:50 PM	Presentation of Institute Report by Dr. G. Pardha Saradhi Varma, Principal, CBIT
5:00 PM	Message by Sri. Abburi Ravi, Guest of Honour
5:05 PM	Message by Sri. Allari Naresh, Guest of Honour
5:15 PM	Address by Dr. N. V. Ramana Rao, Chief Guest
5:25 PM	Presidential Address by "Kavi Kireeti" Dr. V. Malakonda Reddy, President, CBIT
5:35 PM	Announcement of Medals / Awards to students
5:40 PM	Vote of thanks by Ms. S. Simritha Rao, General Secretary
6:00PM	Cultural events follow...

Note: Link for online viewing of the programme is available on institute website
<https://www.cbit.ac.in>

Principal

Chaitanya Bharathi Institute of Technology
(Autonomous)

Conduct, Hyderabad-500 075.





CHAITANYA BHARATHI
INSTITUTE OF TECHNOLOGY (A)

Kokapet (Village), Gandipet, Hyderabad, Telangana-500075 www.cbit.ac.in



COMMITTED TO
RESEARCH,
INNOVATION AND
EDUCATION

42
years

SUDHEE – 2021

3rd -4th March – 2021

S.No	Events	Page No.
1	Core Committee	1-6
2	Invitation	7-8
3	Poster	9
4	HEADSTART - CSE	10-32
5	CIVILISATIONS - Civil	33-38
6	ELECTRET - EEE	39-40
7	MECHANICA- MECH	41-63
8	SYNAPSE - ECE	64-70
9	TECSTASY - IT	71-73
10	NEOZION – BIO-TECH	74
11	CHEMSPARK – Chemical	75-77
12	TECHEON - MCA	78-79
13	YUKTHI -SMS	80

Principal

Chaitanya Bharathi Institute of Technology
(Autonomous)
Gandipet, Hyderabad-500 075.





CHAITANYA BHARATHI
INSTITUTE OF TECHNOLOGY
Kokapet(Village), Gandipet, Hyderabad, Telangana-500075 www.cbit.ac.in



COMMITTED TO
RESEARCH,
INNOVATION AND
EDUCATION
42
years

SUDHEE - 2021
3rd - 4th March, 2021

CORE COMMITTEE

- Advisor** : Dr. G. P. Saradhi Varma, Principal.
Chairman : Dr. N. V. Koteswara Rao, Professor, Department of ECE.
Co-Chairman : Dr. M. Koti Reddy, Professor, Department of Civil Engg.
Convener : Dr. P. Prabhakar Reddy, Professor, Dept. of Mech. Engg.
Co-Convener : Dr. M. Trupthi, Assistant Professor, Department of IT.

All the following Committee members are hereby requested to support and complete their responsibilities for making SUDHEE-2021 a grand success.

1. Publicity and Reception Committee
2. Technical Committee
3. Cyber Committee
4. Accounts & Finance Committee
5. Disciplinary Committee
6. General Maintenance Committee

PRINCIPAL &
Advisor, SUDHEE-2021

4

To the all Heads of the Departments / Head of Sections for information and with a request to arrange for circulation among the faculty and staff under their control & for N/a
To all Directors, Joint Directors, HR, CoE, Librarian & PD- for information & N/a.



Principal
Chaitanya Bharathi Institute of Technology
(Autonomous)
Gandipet, Hyderabad-500 075.



1. PUBLICITY AND RECEPTION COMMITTEE:

1.	Dr. Ravindra Pogaku, Professor, Chemical -HOD & Director RLS	Advisor
2.	Dr. NLN Reddy, Associate Professor, Chemical & Director CDC	Advisor
3.	Dr. P.V.R.Ravindra Reddy, Professor, Mech. & HOD	Chairman
4.	Dr. P.Raj Reddy, Professor, Maths & HOD	Co-Chairman
5.	Dr. Yadavalli Rajasri, Associate Professor, Biotech & I/c. Head	Co-Chairman
6.	Dr. M.V.Krishna Rao, Professor, CIVIL	Co-Chairman
7.	Dr. N.V.Srinivasulu, Professor, Mech.	Convener
8.	Dr. T.Ratna Reddy, Associate Professor, Mech	Co-Convener
9.	Smt. N.Ramadevi, Professor, CSE	Co-Convener
10.	Dr. N.Ravi Dakshina Murthy, Associate Professor, CIVIL	Co-Convener
11.	Dr. Jalaja Enamala, Associate Professor, SMS	Co-Convener
12.	Dr. V.Aruna, Assistant Professor, Biotech.	Member
13.	Dr. K.Raja Gopal, Assistant Professor, Biotech.	Member
14.	Ms. Y.Vineetha, Assistant Professor, Biotech.	Member
15.	Sri K.Prasad Babu, Assistant Professor, Chemical	Member
16.	Mrs. Harsha Nagar, Assistant Professor, Chemical	Member
17.	Dr. Harikrishnan.N, Assistant Professor, Chemical	Member
18.	Dr. M.Mamatha, Assistant Professor, Chemistry	Member
19.	Dr. Satish Kumar Kurapati, Assistant Professor, Chemistry	Member
20.	Ms. T.Malleswari Devi, Assistant Professor, CIVIL	Member
21.	Sri K.V.Vivek, Assistant Professor, CIVIL	Member
22.	Smt. Aswari Sultana Begum, Assistant Professor, CIVIL	Member
23.	Sri R.Swami Ranga Reddy, Assistant Professor, CIVIL	Member
24.	Sri G.Vivek, Assistant Professor, CSE	Member
25.	Sri Ch.V.Krishna Reddy, Assistant Professor, EEE	Member
26.	Sri M.V.Nagabhushanam, Assistant Professor, ECE	Member
27.	Dr. M.Ramana Reddy, Assistant Professor, ECE	Member
28.	Sri N.Jagan Mohan Reddy, Assistant Professor, ECE	Member
29.	Smt. N.Dhanalakshmi, Assistant Professor, ECE	Member
30.	Smt. K.Sugamya, Assistant Professor, IT	Member
31.	Sri D.Jayaram, Assistant Professor, MCA	Member
32.	Dr. B.R.Sreedhar, Assistant Professor, Maths	Member
33.	Dr. G.Deepa, Assistant Professor, Maths	Member
34.	Dr. K.Sharada, Assistant Professor, Maths	Member
35.	Dr. A.Padma, Assistant Professor, Maths	Member
36.	Dr. L.Suresh Kumar, Assistant Professor, Mech	Member
37.	Sri K.Gurubrahmam, Assistant Professor, Mech	Member
38.	Dr. Manowar Hussain, Assistant Professor, Mech	Member
39.	Dr. Rahul, Assistant Professor, Mech	Member
40.	Dr. Puneet Chandran, Assistant Professor, Mech	Member
41.	Dr. Mahendra Babu Kantipudi, Assistant Professor, Mech	Member
42.	Dr. Y.Srinivasa Reddy, Assistant Professor, Physics	Member
43.	Dr. Santhosh Kumar A, Assistant Professor, Physics	Member
44.	Dr.M.Anil Kumar, Assistant Professor, SMS	Member
45.	Smt. K.Bhagya Lakshmi, Assistant Professor, SMS	Member
46.	Smt. M.Sangeetha, Assistant Professor, SMS	Member
47.	Sri P.Srinivasa Reddy, Programmer, AEC	Member
48.	Sri K.Venkat Reddy, Assistant Programmer, T&PO	Member
49.	Sri Y.Chandrasekhar, Assistant Programmer, Mech.	Member
50.	Sri B.Sarat Kumar, Assistant Programmer	Member
51.	Ms. U.Dharani, Computer Operator, CSE	Member



Principal

Chaitanya Bharathi Institute of Technology

(Autonomous)

Gandipet, Hyderabad-500 075.



- iii) To publicize the event by issuing -
- iv) To arrange for the coverage of the event in print and electronic media.
- v) To collect photographs/snap shots of all the events of all the departments.
- vi) To prepare and distribution of e-Invitation Cards.
- vii) To arrange printing of Invitation cards and e-poster, if required.
- viii) To finalize chief guest and guest of honour for both inaugural and valedictory functions with the coordination of principal and core committee members
- ix) To prepare the program sheet for inaugural and valedictory functions
- x) To coordinate with the core committee and all other committees for any required information as per the emerging and dynamic situations.

2. TECHNICAL COMMITTEE :

1.	Dr. A.D.Sarma, Professor, ECE & Director-R&D	Advisor
2.	Dr. P.Ravinder Reddy, Professor, Mechanical	Advisor
3.	Dr. K.Krishna Veni, Professor, EEE & Director Academics	Chairman
4.	Dr. M.V.S.Murali Krishna, Professor, Mech.	Co-Chairman
5.	Dr. A.Vimala, Professor, CIVIL	Co-Chairman
6.	Dr. D.Lakshmi Srinivasa Reddy, Associate Professor, Head, MCA	Co-Chairman
7.	Dr. P.Narahari Sastry, Professor, ECE	Convener
8.	Dr. M.Balasubba Reddy, Associate Professor, EEE	Co-Convener
9.	Dr. R.Ravinder Reddy, Associate Professor, CSE	Co-Convener
10.	Dr. A.Supraja Reddy, Associate Professor, ECE	Co-Convener
11.	Dr. S.Solomon Raj, Associate Professor, Mech	Co-Convener
12.	Dr. C.Nagendranatha Reddy, Assistant Professor, Biotech	Member
13.	Smt. N.Lalitha Kumari, Assistant Professor, CIVIL	Member
14.	Sri P.Srinivasa Reddy, Assistant Professor, CIVIL	Member
15.	Sri R.Ranga Reddy, Assistant Professor, CIVIL	Member
16.	Sri E.Maheswar Reddy, Assistant Professor, CIVIL	Member
17.	Dr. P.Yugendar, Assistant Professor, CIVIL	Member
18.	Smt. Ch.Madhavi Sudha, Assistant Professor, CSE	Member
19.	Smt. I.Srujana, Assistant Professor, CSE	Member
20.	Smt. A.Sangeetha, Assistant Professor, CSE	Member
21.	Smt. E.Kalpna, Assistant Professor, CSE	Member
22.	Smt. K.Mary Sudha Rani, Assistant Professor, CSE	Member
23.	Smt. T.Suvarna Kumari, Assistant Professor, CSE	Member
24.	Sri E.Chandrashekar, Assistant Professor, ECE	Member
25.	Sri P.Sathish, Assistant Professor, ECE	Member
26.	Dr. K.Suman, Assistant Professor, ECE	Member
27.	Sri G.Mallikarjuna Rao, Assistant Professor, ECE	Member
28.	Sri G.V.Pradeep Kumar, Assistant Professor, ECE	Member
29.	Dr. N.V.Phanendra Babu, Assistant Professor, EEE	Member
30.	Sri N.Santosh Kumar, Assistant Professor, EEE	Member
31.	Dr. Ahmed Syed, Assistant Professor, EEE	Member
32.	Mrs. P.Naga Chaitanya, Assistant Professor, EEE	Member
33.	Mrs. B.Venkata Haritha, Assistant Professor, EEE	Member
34.	Sri B. Krishna Chaitanya, Assistant Professor, EEE	Member
35.	Dr. P.Madhuri, Assistant Professor, Chemical	Member
36.	Dr. Saritha.D, Assistant Professor, Chemistry	Member
37.	Smt. Kratika Sharma, Assistant Professor, IT	Member
38.	Smt. E.Ramalakshmi, Assistant Professor, IT	Member



Principal

Chaitanya Bharathi Institute of Technology

(Autonomous)

Gandipet, Hyderabad-500 075.



39.	Smt. K.Swathi, Assistant Professor, IT	Member
40.	Dr. B.Veera Jyothi, Assistant Professor, IT	Member
41.	Sri K.Gangadhar Rao, Assistant Professor, IT	Member
42.	Ms. D.S Madhuri, Assistant Professor, Mech	Member
43.	Smt. KNV Sreedevi, Assistant Professor, Mech	Member
44.	Sri Chintireddy Sharath Reddy, Assistant Professor, Mech	Member
45.	Sri CNVBR Sri Gowrinath, Assistant Professor, MCA	Member
46.	Sri P.Krishna Prasad, Assistant Professor, MCA	Member
47.	Dr. Neelima Agarwal, Assistant Professor, Physics	Member
48.	Dr. K.Sowmya, Assistant Professor, SMS	Member
49.	Smt. B.Kavitha, Programmer, IT	Member
50.	Smt. T.S.Praveena, Programmer, MCA	Member
51.	Sri K Ravi Kiran Reddy, Assistant Programmer, AEC	Member
52.	Smt. K.Srilatha, Computer Operator, CSE	Member

Responsibilities:

- i) To decide the format for Technical papers / Abstracts and communicate the same to all the departments.
- ii) To formulate rubrics for evaluation of technical events and communicate the same to all the departments.
- iii) To bring out soft copy of the Souvenir / CD of SUDHEE-2021.
- iv) To compile and consolidate the prizes to be announced and distributed pertaining to all events of all departments .
- v) To compile information about all keynote sessions of each department
- vi) To formulate modalities for technical quiz in coordination with respective departments.
- vii) To formulate modalities for Poster Presentation/Project Models/ Mini Project/ Product Display in coordination with respective departments.
- viii) To design E-Certificates for all the activities of SUDHEE-2021 and share the required number of certificates to the respective departments.
- ix) To inform the list of Keynote Speakers, Jury and Prize Winners in coordination with the departments to the finance committee for arranging Honorarium and prize money respectively.
- x) To circulate one hardcopy of printed and bounded souvenir to each department, after the event which includes necessary information.
- xi) To coordinate with the core committee and all other committees for any required information as per the emerging and dynamic situations.

3. CYBER COMMITTEE:

1	Dr. Umakanth Chowdary, Professor, EEE & Director - I & I	Advisor
2.	Dr. M.Swamy Das, Professor, CSE & Joint Director, Academics	Chairman
3.	Dr. K.Lakshmi, Professor & HOD, Chemistry	Co-Chairman
4.	Dr. S.Saraswathi, Associate Professor, SMS & I/c. Head	Co-Chairman
5	Dr. K.Radhika, Professor, IT & HOD	Convener
6	Dr. T.Murali Krishna, Associate Professor, EEE	Co-Convener
7	Dr. T.Sudhakar Babu, Associate Professor, EEE	Co-Convener
8.	Dr. Swatmaram, Associate Professor, Maths & Asst CoE	Co-Convener
9	Dr. G Vijaya Laxmi, Assistant Professor, Biotech.	Member
10.	Dr. Anitha M, Assistant Professor, Chemical	Member
11	Dr. M Rama Devi, Assistant Professor, Chemistry	Member
12	Smt. P.Vimala M Ruth, Assistant Professor, CSE	Member
13.	Sri K Kiran Prakash, Assistant Professor, CSE	Member
14	Smt. D.Naga Jyothi, Assistant Professor, CSE	Member
15.	Smt. S.Durga Devi, Assistant Professor, CSE	Member

Principal

Chaitanya Bharathi Institute of Technology
(Autonomous)
Gandipet, Hyderabad-500 075.



16.	Smt. E.Swathi, Assistant Professor, CSE	Member
17.	Smt. Isha Padhy, Assistant Professor, CSE	Member
18.	Sri M.Venkata Krishna Reddy, Assistant Professor, CSE	Member
19.	Mrs. K.Dharani Tejaswini, Assistant Professor, CSE	Member
20.	Ms. R.Madhurima, Assistant Professor, CSE	Member
21.	Sri P.Ranjith, Assistant Professor, ECE	Member
22.	Sri MD.Sikandar, Assistant Professor, ECE	Member
23.	Smt. Ghata Chauhan, Assistant Professor, ECE	Member
24.	Dr. M Raj Kumar Naik, Assistant Professor, ECE	
25.	Dr. N.Vasantha Gowri, Assistant Professor, EEE	Member
26.	Sri N.Santosh Kumar, Assistant Professor, EEE	Member
27.	Dr. Ahmed Syed, Assistant Professor, EEE	Member
28.	Mrs. P.Naga Chaitanya, Assistant Professor, EEE	Member
29.	Smt. T.Satya Kiranmai, Assistant Professor, IT	Member
30.	Smt. Deepa.R, Assistant Professor, IT	Member
31.	Smt. B.Surya Samantha, Assistant Professor, IT	Member
32.	Sri K.Rajesh Kannan, Assistant Professor, IT	Member
33.	Sri R.Govardhan Reddy, Assistant Professor, IT	Member
34.	Dr. B.Indira, Assistant Professor, MCA	Member
35.	Sri P.Kiran Kumar, Assistant Professor, Mech.	Member
36.	Dr. Ch Indira Priyadarshini, Assistant Professor, Mech.	Member
37.	Dr. B.V.S.Rao, Assistant Professor, Mech.	Member
38.	Smt. N.Jyothirmai, Assistant Professor, Mech.	Member
39.	Smt. P.Anjani Devi, Assistant Professor, Mech.	Member
40.	Dr. P.Rama Lakshmi, Assistant Professor, Mech.	Member
41.	Smt. Ch.V.Sushma, Assistant Professor, Mech.	Member
42.	Dr. S.Shravan Kumar Reddy, Assistant Professor, PHY	Member
43.	Dr. M.Narender, Assistant Professor, SMS	Member
44.	Sri E.Sanjeeva Reddy, SPP-IA System Engineer	Member
45.	Sri B.Sangeev Kumar, Programmer, ECE	Member
46.	Sri B.Sarat Kumar, Asst. Programmer, Library	Member
47.	Sri R.Anand Raj, Asst. Programmer, CSE	Member
48.	Sri R.Navanadh, Computer Operator, CSE	Member
49.	Sri G.Venkata Kishore, Computer Operator, IT	Member
50.	Sri K.Lakshmana, Sr. Research Asst., R & D	Member
51.	Sri K.Suresh Verma, Computer Operator, AEC	Member
52.	Sri Syed Shanawaz Basha, Computer Operator, AEC	Member

Responsibilities:

- i) To facilitate the necessary infrastructure for online platform in consultation with the respective departments.
- ii) To arrange provision in the website to post the respective department fest Links.
- iii) To create the necessary link(s) for Inaugural/ Valedictory Session.
- iv) To create the necessary link(s) for all the department level technical events.
- v) To facilitate the recording of all the online events.
- vi) To facilitate the conduct of Inaugural session, keynote lecture and valedictory sessions.
- vii) To create the necessary Google forms as requested by the respective departments.
- viii) To create registration links for the participants for their respective events of the concerned departments.
- ix) To coordinate with all departments for any other Cyber Links.
- x) To coordinate with the core committee and all other committees for any required information as per the emerging and dynamic situations.

Principal



Chaitanya Bharathi Institute of Technology
(Autonomous)
Gandipet, Hyderabad-500 075.

6. GENERAL MAINTENANCE COMMITTEE:

1.	Sri K.R.K. Prasad, Project Engineer	Chairman
2.	Sri S. Lakshmi pathi, Maintenance	Convener
3.	Sri P.Srinivas, Maintenance	Co-Convener
4.	Sri K.Vara Prasad, Sr Asst., AEC	Member
5.	Sri G Bangar Reddy, Sr. Asst, AEC	Member
6.	Smt. D.Madhavi latha, Technician, Biotech.	Member
7.	Smt S.Kavitha, Technician, Biotech	Member
8.	Sri M.Laxmana Chary, Technician, Chem	Member
9.	Sri V Sanjeeva Reddy, Technician, Chem	Member
10.	Sri G.Mahender Reddy, Technician, Chemistry	Member
11.	Sri CH Harinarayana Reddy, Lab Assistant, CIVIL	Member
12.	Sri K.Balaiah, Technician, CIVIL	Member
13.	Sri S.Chandra Reddy, Technician, ECE	Member
14.	Sri N.Seshagiri Rao, Technician, ECE	Member
15.	Sri N.Krishnaiah, Skilled Asst, ECE	Member
16.	Sri M.P.Radha, Technician, ECE	Member
17.	Sri K.Komaraiah, Technician, EEE	Member
18.	Sri K.Malles, Technician, EEE	Member
19.	Sri A.Krishnama Chary, Technician, EEE	Member
20.	Sri M.Kishore, Technician, EEE	Member
21.	Sri A.Shyamaiah CHARY, Jr. Library Asst.	Member
22.	Ms. D.Neetha, Jr. Library Asst.	Member
23.	Sri J.Pradeep Kumar, DEO as Jr Asst (C)	Member
24.	Sri A.Nagaiah, Technician, Mech	Member
25.	Sri M Laxmaiah, Technician, Mech.	Member
26.	Sri E Satayanarayana, Technician, Mech.	Member
27.	Sri R.Kumar, Technician, Mech	Member
28.	Sri K.Raj Gopal, Technician, Mech	Member
29.	Sri E.Ramesh, Skilled Asst, Mech.	Member
30.	Sri V.Bhaskar, Technician, Mech.	Member
31.	Sri V Srinivas, Technician, Mech.	Member
32.	Sri S.Narasimha Reddy, Lab Assistant, Physics	Member
33.	Sri S.Siva Kumar, Technical, Physics	Member
34.	V.Jyothi, Attender/Sweeper, AEC	Member
35.	B.Praveen Kumar, Attender, AEC	Member
36.	B.Yadagiri, Attender, CIVIL	Member
37.	C.Sreenivas, Attender, ECE	Member
38.	B.Narasimha, Electrician, Maintenance	Member
39.	B.C. Pullaiah, Attender, Maintenance	Member
40.	U.Uma Rani, Attender, Maintenance	Member

Responsibilities:

- To look after the General Maintenance aspects during SUDHEE-2021 in the campus.
- To coordinate with the core committee and all other committees for any required information as per the emerging and dynamic situations

M

QPS
PRINCIPAL &
Advisor, SUDHEE-2021

(Handwritten Signature)

Principal

Chaitanya Bharathi Institute of Technology

(Autonomous)

Gandipet, Hyderabad-500 075.





The Management, Principal, Staff and Students of
CHAITANYA BHARATHI INSTITUTE OF TECHNOLOGY(A)
Affiliated to Osmania University, Hyderabad
UG Programmes are Accredited by NBA, Accredited by
NAAC-UGC with 'A' Grade An ISO 9001:2015 Certified
Institution

Cordially invite you to grace the
INAUGURAL FUNCTION
of
SUDHEE-2021
National Level Students' Technical Fest
On Wednesday, 3rd March 2021 at 10.30 AM
Venue : through on line

Prof. R.Hariharan
Advisor-II, Approval Bureau
All India Council for Technical Education, New Delhi
has kindly consented to be the Chief Guest

Sri. E.S.Chakravarthy Global RMG
Head & Vice President Tata Consultancy
Services, Bengaluru
has kindly consented to be the Guest of Honour

'Kavi Kireeti' Dr. V. Malakonda Reddy
President, CBIT
will preside over the function

Prof. N.V.Koteswara Rao
Sudhee-2021

Prof. G.P.S. Varma Chairman,
Principal & Advisor, Sudhee-2021

7

O. Anand
Principal



Chaitanya Bharathi Institute of Technology
(Autonomous)
Gandipet, Hyderabad-500 075.

PROGRAMME

- 10:30 AM *Invocation*
- 10:35 AM *Welcome Address by*
Prof. G.P.S. Varma
Principal & Advisor, *SUDHEE-2021*
- 10:45 AM *About SUDHEE-2021 by*
Prof. N.V.Koteswara Rao
Chairman, *SUDHEE-2021*
- 10:50AM *Address by*
Sri. E.S.Chakravarthy
Guest of Honour
- 11:05 AM *Address by*
Prof. R.Hariharan
Chief Guest
- 11:20 AM *Presidential address by*
'Kavi Kireeti' **Dr. V. Malakonda Reddy**
- 11:30 AM *Vote of thanks by*
Prof. P.Prabhakar Reddy
Convenor, *SUDHEE-2021*

-oOo-



Principal
Chaitanya Bharathi Institute of Technology
(Autonomous)
Gandipet, Hyderabad-500 075.

Poster of Sudhee



CHAITANYA BHARATHI
INSTITUTE OF TECHNOLOGY (A)
Kokapet(Village), Gandipet, Hyderabad, Telangana-500075 www.cbit.ac.in

Approved by
AICTE
1987
SAAS
nir
ISO
9001:2015

COMMITTED TO
RESEARCH,
INNOVATION AND
EDUCATION

42
years

Proudly Presents

SUDHEE'21

3rd and 4th of March
Theme: DIGITAL INNOVATIONS IN 21st CENTURY
A National Level Student's Technical Fest

HEADSTART (CSE)	CIVILISATIONS (CIVIL)	ELECTRET (EEE)	MECHANICA (MECH)	SYNAPSE (ECE)	TECSTASY (IT)	NEOZION (BIO-TECH)	CHEMSPARK (CHEMICAL)	TECHEON (MCA)	YUKTHI (SMS)



Principal
Chaitanya Bharathi Institute of Technology
(Autonomous)
Gandipet, Hyderabad-500 075.



CHAITANYA BHARATHI
INSTITUTE OF TECHNOLOGY (A)
Kokapet (Village), Gandipet, Hyderabad, Telangana-500075. www.cbit.ac.in

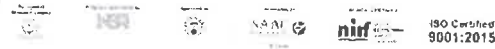

COMMITTED TO
RESEARCH
INNOVATION AND
EDUCATION

42
years

Sudhee 2021

Department of Computer Science and Engineering

HEADSTART 2021

Transcending Innovations

About Headstart

Headstart is the two-day National-Level Technical Fest of CSE Department organized under the umbrella of Sudhee, the Technical Fest of CBIT. Headstart has organized 11 ecstatic events during the year 2020-2021. The fest was conducted on the 3rd and 4th of March, 2021 with a huge turnover of students. We had **1223** participants altogether.

Support from College

The College Management, Principal, Sudhee Core Committee, Head of the Department have encouraged, supported and guided us in this endeavor.

Faculty Coordinators:

1. Smt. P. Vimala Manohara Ruth, Asst. Professor



2. Smt. Ch. Madhavi Sudha, Asst. Professor



Principal
Chaitanya Bharathi Institute of Technology
(Autonomous)
Gandipet, Hyderabad-500 075.

Student Coordinators:

1. Y. Sai Rakshitha



2. E. Dora Sai Varma



3. D. Harshavardhan

DETAILS ABOUT THE EVENT

Inaugural Ceremony

The Opening Ceremony of Headstart, was conducted online at 11:30 AM on 3rd March, 2021. The ceremony was presided over by the Head of the Department of CSE, Professors, faculty members and the Keynote Speaker. The speaker, Mr. Pankaj Diwan, then addressed the crowd. The conference was officially declared open.

Speaker: Mr. Pankaj Diwan, Founder, Idealabs FutureTech Ventures Topic: Emerging Technologies

Event Dates: 3rd and 4th March 2021

Event Website: <https://headstart.cbit.org.in/>



Principal
Chaitanya Bharathi Institute of Technology
(Autonomous)
Gandipet, Hyderabad-500 075.

Keynote Speaker – Inaugural



Mr. Pankaj Diwan

Profile:

Moonshot thinker, Day dreamer, Self-confessed technology addict, active enabler in the startup ecosystem and an eternal optimist! He is the founder of Idealabs FutureTech Ventures, India's largest Innovation Consulting and up-skilling company and Co-Founder of Block91, a boutique Blockchain company. He started his first company just out of campus almost two decades ago. In his capacity as Managing Director of Idealabs, he works closely with governments, policy makers to build a framework for ushering innovation and entrepreneurship.

Some Professional milestones:

Advisor at Global Entrepreneur Foundation. South Korea's largest Start-up initiative, Indo-German Consortium for Education, Indo-Swedish Startup Accelerator. Advisor and mentor on the board of several startups working on solutions in emerging technologies like IoT, Blockchain and AI/ML. Mentor at T-Hub, India's largest Start-up ecosystem engine. Co-Chair for open Innovation, State Innovation cell, Govt. of Telangana. Convenor of Hyderabad Product leaders, a group of product leaders drawn from top notch product companies. Founding member of Hyderabad Hackers, a group working in seeding the Start-up ecosystem in Hyderabad through various enabling initiatives.

Principal

**Chaitanya Bharathi Institute of Technology
(Autonomous)**

Gandipet, Hyderabad-500 075.



Guest Speaker – Valedictory



Mr. Surya Putchala

Profile:

Surya, provided thought leading consulting solutions in the areas of Business Intelligence, Data Warehousing, Data Management and Analytics to Fortune 500 Clients over the last 2 decades. He achieved demonstrable results for many clients through consulting and solving complex decision making environments. Currently the vision behind the comprehensive customer experience management platform called CXP and a Data Science Platform called - "ZettaMine". Earlier, he architected commercial Analytical Applications for Product MDM (epaCUBE) and Procurement Optimization (SolPro). He has helped many large System Integration programs achieve productivity benefits through creating smart solutions and accelerators.

Surya has a tremendous zeal to create Analytics products that bring significant improvements in Business Performance. He is passionate about areas related to Data Science, Big Data, High Performance Cluster Computing and Algorithms. His current interests are building customer solutions in Data Science (Machine Learning, Statistical Analysis, Natural Language Processing), Big Data (Hadoop, Spark, Storm, NoSQL), Technology Transformations (Strategy, Value Articulation, Architecture, Assessments, Portfolio analysis and rationalization).

13

A handwritten signature in green ink, appearing to read "S. Putchala".

Principal

**Chaitanya Bharathi Institute of Technology
(Autonomous)**

Gandipet, Hyderabad-500 075.



	<p>Wearing several hats such as Vice President of TDWI (India Chapter), Gardener of Hyderabad Hadoop User Group, Founder of Hyderabad Data Science Group, he constantly endeavors to evangelize the adoption of quantitative techniques for decision making in various verticals. He believes analytics should be extensively utilized in both businesses and in society to create effective systems and has direct impact on better service delivery and customer experience. He held senior leadership roles with firms such as GE capital, Cognizant, Accenture and HCL. He graduated from IIT Kharagpur. He has :</p> <p>About 25 years of global professional career in the field of Information Management.</p> <p>Trusted consultant to Fortune 500 on articulating and deriving true benefit and value from their investments in technology; and enabling them to transform and increase business alignment.</p> <p>Reliable solutions architect – provided thought leading, practical and cutting-edge solutions in the areas of Business Analytics that deliver superior performance. Expert in Service Delivery enablement and oversight. Delivered cost-effective and repeatable projects by establishing standards and methodologies focusing on health-checks, design reviews, assessments, estimation and requirements analysis.</p> <p>Effective in influencing sales revenues by consultative solutioning, customer engagement, collaboration, scoping, value articulation, proof of concepts, proposals and innovating service lines or creating new offerings.</p> <p>Excellent ability to evangelize adoption of Information Management through speaking engagements, publishing, industry - academia connect, Knowledge sharing and community education through various Industry forums.</p>
--	---

A. Anand
Principal



	Regarded as a thought leader in India and a sought after Speaker / Panelist/ Moderator and Chair at Conferences in India.
--	---

The schedule for the events was as follows:

Headstart 2021 Inaugural Function

Date & Time:

03-03-2021 11:45 AM to 12:30 PM

Event: Keynote Address started at 12:00 noon

Speaker: Mr. Pankaj Diwan

Topic: Emerging Technologies

Audience: 54 Count

Youtube: 384 Views

Links:

<https://drive.google.com/file/d/1wPi6OvgE3ihceest2PdsqfveqTfKqeH/view?usp=sharing>

P. Anand



to

<https://www.youtube.com/watch?v=cX1HKTqFpS8>

Photos:

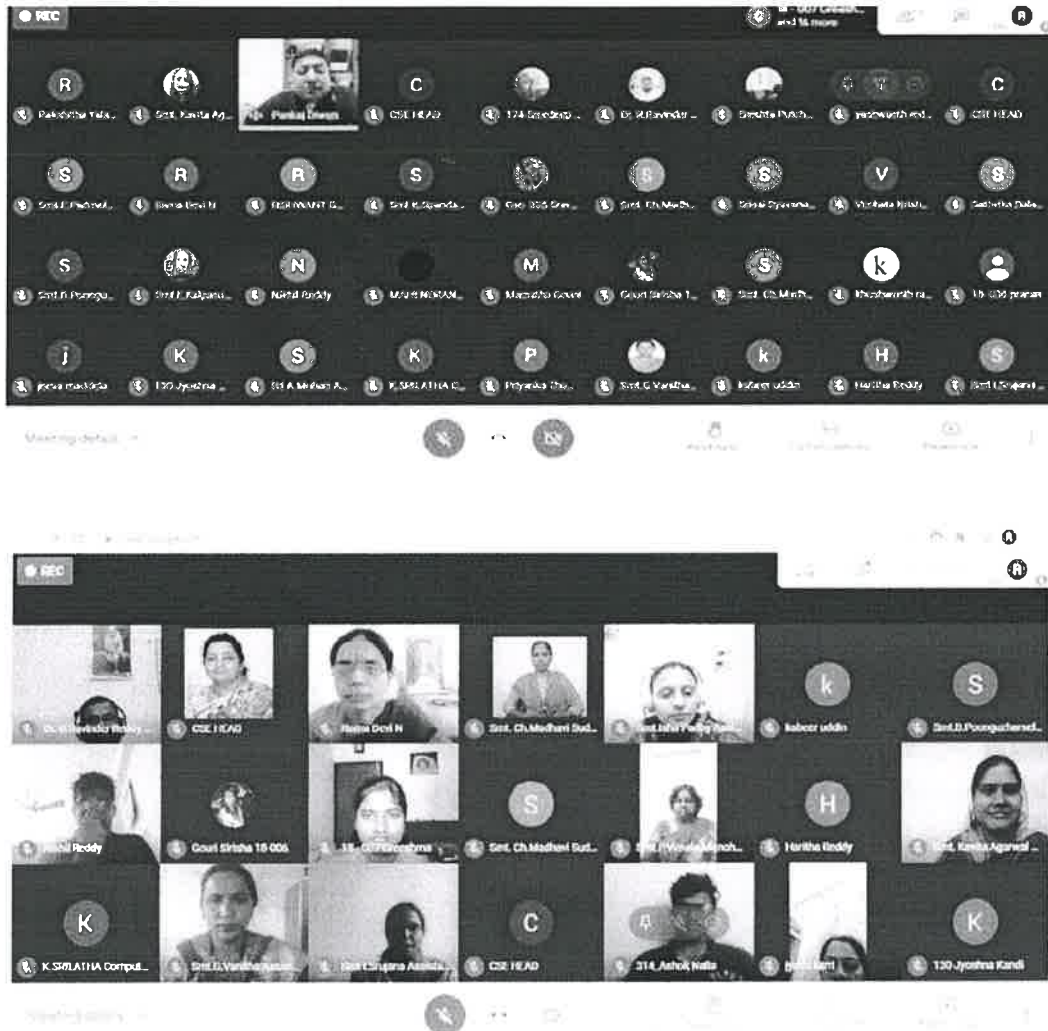

Event 1: Technical Paper Presentation

Event Description:

Here is an amazing opportunity to showcase your ideas on a unique and massive platform in the form of well integrated and intriguing presentation. It strives to explore the competency of young minds by giving their incredulous ideas a definitive direction. There are two stages in this event where in the first stage is submission of abstract and the next one is the final round where students have to present in front of judges. Evaluation is done in front of highly qualified judges.

Principal



Date and Time:

03-03-2021 1:00- 4:00pm

04-03-2021 11:00- 12:00 & 1:00 - 3:00pm

No. of Participants: 32

Faculty Committee/Jury: Dr. E. Padmalatha, Ms. G. Vanitha, Ms. T. Suvarna Kumari

Winners:

Prize-1 Sushmitha, CSE Dept, Diploma, Government Institute of Electronics.

Prize-2 Karthik Devroy D,CSE Dept, ACE Engineering College.

Links:

<https://drive.google.com/file/d/1uBZi92PPwW5alPPYvYRi8FBLGPoZMvnD/view?ts=604071e7>

https://drive.google.com/file/d/14jYY74e_3i7KSxN17GgM5e_5xz-jmvm/view?ts=604086f8

https://drive.google.com/file/d/1QOTcq3v6wIYk0FEUZp_BdEpYDokjVbXq/view?ts=6040a665

<https://drive.google.com/file/d/1t6QqBaKCF2T3mKYDR5l4tnG7qIOpAXE4/view?usp=sharing>

<https://drive.google.com/open?id=1Yrzm5ADTJWZPJYLDVmLZpOY8gokhiUmM>

Photos:



Principal

**Chaitanya Bharathi Institute of Technology
(Autonomous)**

Gandipet, Hyderabad-500 075.



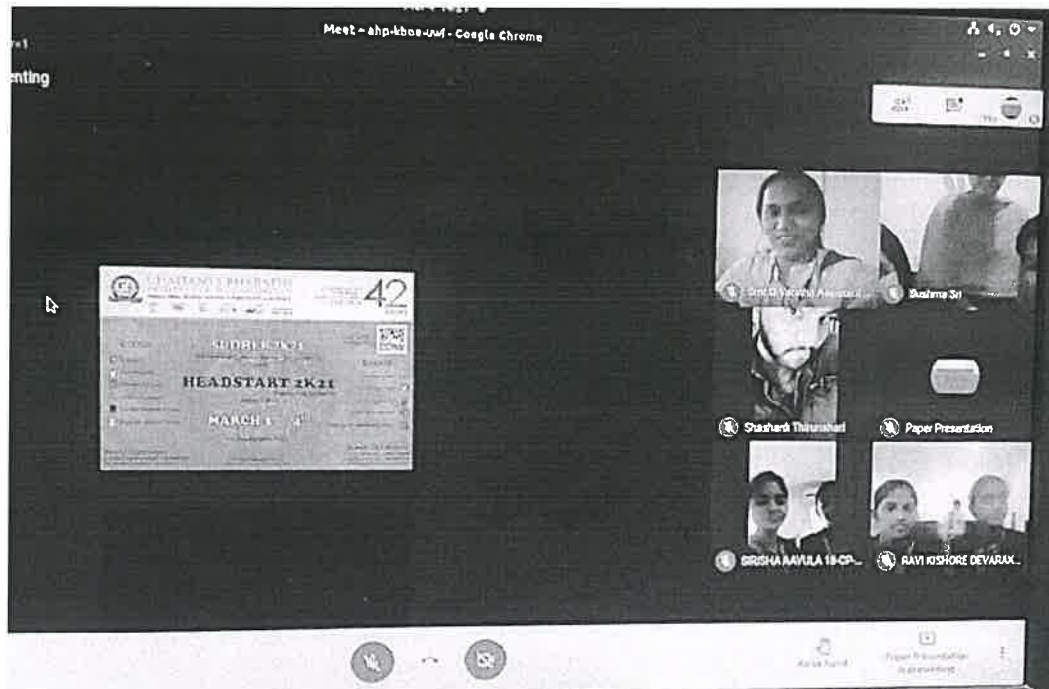

Event 2: Technical Poster Presentation

Event Description: Poster presentation – Ideathon is a platform which provides you with an amazing opportunity to showcase your ideas on a unique platform in the form of a poster presentation. Posters are legitimate and popular presentation format for research and clinical vignettes. They efficiently communicate concepts and data to an audience using a combination of visuals and text.

Date & Time:

03/03/2021 3:30pm - 4:00pm

04/03/2021 12:30pm-2:00pm

No. of Participants: 09

Faculty Committee/Jury: I.Srujana ,Ch.VijayaLakshmi,K.Spandana

Winners:

Prize-1 T.Manju Priyanka, MTech CSE CBIT

Prize-2:G Sai Prathyusha,2nd CSE CBIT

Links: <https://drive.google.com/folderview?id=1eTJoQ1HzL7jBs2yzcKwR7aGZEdfAvdun>

Photos:

 18
Principal
Chaitanya Bharathi Institute of Technology
(Autonomous)
Gandipet, Hyderabad-500 075.





Event 3: Technical Project/Prototype Presentation

Event Description

Project presentation is a platform which provides you with an awestruck opportunity to showcase best of the projects you worked on!! Projects make 60% of your entire resume which is a summary of your entire career! You will be guided by the judges who have been a great backbone and made CBIT the only college in the entire nation which alone had 5 winning teams in SIH conducted by the central government! Grab this platform to clear all your confusions and get a boost! We provide you a platform to come and see different projects in different domains and gain knowledge and take guidance and pave your way ahead!!

Time:

03-03-2021 2:00pm - 3:45pm

04-03-2021 10:00am-11:40am

No. of Participants: 17

Faculty Committee/Jury: Smt E.Kalpana, Smt D. Naga Jyothi

Winners:



Prize1: Simrah Munaza Ikram, CSE, MGIT

Prize2: Koutilya Reddy, M.Tech CSE, CBIT

Links:

https://drive.google.com/file/d/16jSHjBfgScZUMb3oOTA872ed_2C3fTjx/view?usp=sharing

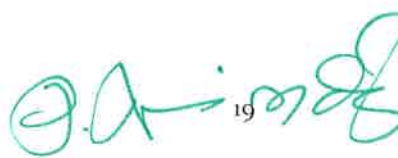
Photos:

19  

Principal
Chaitanya Bharathi Institute of Technology
 (Autonomous)
 Gandipet, Hyderabad-500 075.



Event 4: Technical Online Quiz- FAST AND FURIOUS

Event Description: A fun and supersonic celebration of technology!!"

Get ready for a roller coaster ride into the intense world of techno quizzing. Fast and Furious gives you the experience of fastest-finger-first game wherein you will be racing against and trying to overrun your friends and peers by answering a series of 15 technical and aptitude questions quickly and accurately. In each race, the fastest performers among the teams participated, are promoted to the next round. The final round is a "Surprise Round", a haven for those with the technical chutzpah to display your geekiness. You will be given details of round-3 only after finishing the first two rounds. We await the crowning of the next tech wizards.

Date and Time:

03/03/2021 01:00PM - 03:00PM and 06:00 PM - 08:00PM

04/03/2021 10:00AM - 02:30PM

No. of Participants:154

Faculty Committee/Jury: Sri B.Ramadasu ,Sri A.Mohan

Winners:

Prize1: Supreet V CSE, CBIT

Prize2: Yashwanth Javvaji,CSE, CBIT

Links:https://drive.google.com/drive/folders/1vZyGnMn2zTj5Y_WHCrtkwSSXAaSGw

fmC

Photos:

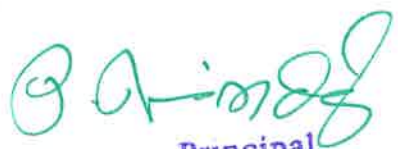
 20
 Principal
 Chaitanya Bharathi Institute of Technology
 (Autonomous)
 Gandipet, Hyderabad-500 075.





Event 5: Kodecrypt

Event Description:

Kodecrypt is the flagship event of Headstart, which tests your programming and problem solving skills. You must solve tricky and interesting programming questions in any language of your choice.

The event has 3 rounds.

Round 1 - Basic MCQ questions.

Round 2 & 3 are online coding rounds.

There's something more in the store.

You can directly reach the final round through:

Kodecrypt Long Challenge where all the previous Kodecrypt questions are posted and are available for a period of 10 days.

Kodecrypt Wild card Questions is an extra layer where in people who solve at the earliest qualify

Date and Time:

03/03/2021 10:00AM -6:00PM

04/03/2021 1:00PM -3:00PM

No. of Participants: 190

Faculty Committee/Jury: Smt. S. Durga Devi, Sri M. Venkata Krishna

Winners:

Prize1: Murugesan Subramani, CSE CBIT

Prize2: Yashwanth Javvaji, CSE CBIT

Principal

Chaitanya Bharathi Institute of Technology

(Autonomous)

Gandipet, Hyderabad-500 075.



Links:<https://drive.google.com/folderview?id=10wsSZQRlt6wGsgN2rV474cVcVMyyM9g8>

Photos:

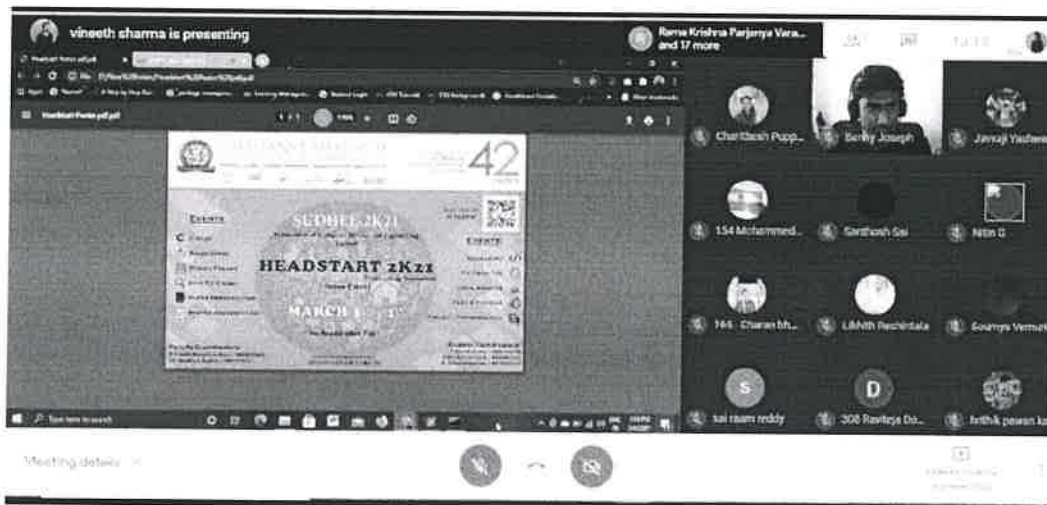

Event 6: Bug Beaters

Date & Time:

03/03/2021 1 pm to 2:30 pm and 6 pm to 7:30 pm

04/03/2021 1 pm to 2:30 pm

Event Description:

BugBeaters is a debugging event. It tests participants' ability to find corner cases and solve minor issues present in the code and come up with a working solution for the given problem statement. It consists of 2 rounds where each round is an elimination round. Both the rounds are online rounds. Apart from these we will be organizing a few pre-contests and the top performers of those contests will get into the final round.

No. of Participants: 74

Faculty Committee/Jury: G.Mamatha

Winners:

Prize1 Roshan ,CSE CBIT

Prize2 Abhishek,CSE CBIT

Links:

https://drive.google.com/file/d/1jhU4SbVvGyldx_LiF1YkoRpQticOU-0M/view?usp=drivesdk

Photos:

A handwritten signature in green ink, appearing to be 'G. Mamatha'.

22

Principal
Chaitanya Bharathi Institute of Technology
(Autonomous)
Gandipet, Hyderabad-500 075.





Event 7: DESIGN FREAKS

Event Description:

Design freaks is an established and popular event of Headstart which focuses on how well a person can design eye catching User Interfaces (UI) for web applications

Round 1: MCQ's related to basic design concepts of Web

Round 2: constitutes of some practical stuff like creating some components of a web page .

Round 3: The participants need to develop a static website which would be evaluated and winner will be decided.

Time:

03/03/2021 1:00PM-2:00PM and 3:00PM-4:00PM

04/03/2021 10:00AM-2:00PM

No. of Participants: 113

Faculty Committee/Jury: Kavita Agrawal ,Ramana Reddy

Winners:

Prize1: G Varsha, CSE CBIT

Prize2: P Sai Akhil, CSE CBIT

Links: <https://drive.google.com/drive/folders/1Sd7wnrG7X8pMhzej0TIoGBKP7feqw0k7?usp=sharing>

Photos:

Principal

**Chaitanya Bharathi Institute of Technology
(Autonomous) 23
Gandipet, Hyderabad-500 075.**





Event 8: Data Addicts

Event Description:

DataAddicts is an event based on DBMS. It provides the perfect platform to showcase your querying skills. It provides intriguing challenges to test your passion for database systems.

This event has 3 rounds along with an introductory session for beginners.

Round 1: consists of basic multiple choice questions

Round 2: you will have to write DBMS queries for given questions.

Round 3: you will have to execute the queries for given database

Date & Time:

03/03/2021 1:00 PM - 5:00 PM

04/03/2021 10:00 AM - 2:00 PM

No. of Participants: 109

Faculty Committee/Jury: Smt. E. Swathi, Sri. K. Kiran Prakash

Winners:

Prize1: P.Rohan Goud CSE CBIT

Prize2: Pavan Kalyan Inugurthi, IT, CBIT

Links: https://drive.google.com/drive/folders/1U0c_ZatL4G0qUvXa1rRv5bVO8OeiPC1

iii

Photos:

Principal
Chaitanya Bharathi Institute of Technology
(Autonomous)
Gandipet, Hyderabad-500 075.





Event 9 : C-Star

Event Description: This event brings you an opportunity to prove your skills in C. You can tackle questions from basics to the complex of its concepts.

This event consists of 3 rounds.

Round 1 consists of basic online MCQs.

Round 2 is online MCQs that are to be solved at a specified time.

Round 3 is the debugging round. The ones clearing round 3 are given merit certificates and exciting prizes & the ones clearing round 2 will be given participation certificates.

Date & Time:

03/03/2021 1:00 p.m. - 6:00 p.m.

04/3/2020 11:30 a.m. - 3:00 p.m.

No. of Participants: 213

Faculty Committee/Jury: Isha Padhy, Poonguzharselvi

Winners:

Prize 1: M Sai Roshan, CSE CBIT

Prize 2: Saketh Reddy Burra, Civil-CBIT

Links:

<https://drive.google.com/file/d/1hwGshM1hRD1824s9r-1vhUGdCqMYNV-X/view?usp=drivesdk>

<https://drive.google.com/file/d/1BdvrfpyQO2FUjARzLZna1v1cQ5tqcyTP/view?usp=drivesdk>

 Principal
 Chaitanya Bharathi Institute of Technology
 (Autonomous)
 Gandipet, Hyderabad-500 075.



vesdk

Photos:



Event 10: Tic Tech Toe

Event Description: This event is based on the traditional game TIC Tech TOE. Each participant is expected to solve the logical questions in a vertical or horizontal or diagonal direction. Players who solves two lines in the given time limit will be considered for the next round. Round 1: Online Aptitude test. Round 2: TIC TECH TOE game. Round 3: Creative Analysis.

Data & Time:

03/03/2021 12:30 PM-1:30 PM & 4:00PM -5:00PM & 6:00PM -7:00PM

04/03/2021 1:00PM -2:30PM

No. of Participants: 104

Faculty Committee/Jury: Sri R Srikanth, Smt Dharani Tejaswini

Winners:

Prize1: Vinay Y , CSE CBIT

Prize2: Dinesh Kella, ECE, ICFAI

Links: <https://drive.google.com/drive/folders/1Y2W90Zqh0ro6IAGMHgFg29dEz5N5TahN?usp=sharing>

Photos:

26

Principal

Chaitanya Bharathi Institute of Technology
(Autonomous)
Gandipet, Hyderabad-500 075.



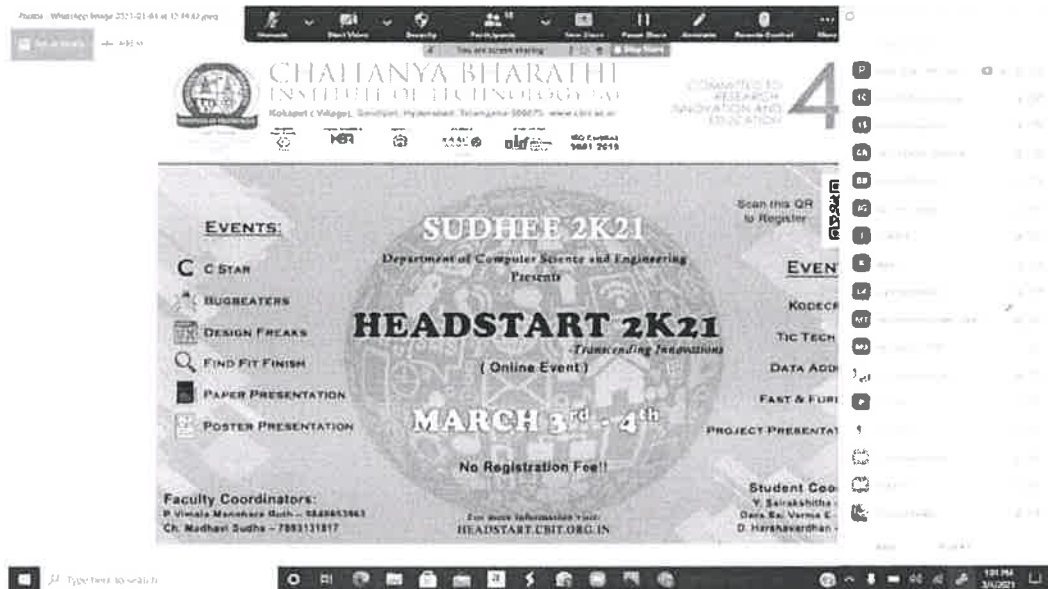

Event 11 : Find Fit Finish

Event Description:

Find Fit Finish is an event that tests the quickness of an individual.

In the first round "Logical Quiz", we will be testing the IQ of an individual through a logical quiz. The second round "Google It Out" would check how quickly an individual can reach a desired target by searching for clues in suitable websites.

The third round "Inter Knack" would be a knockout round where we will be testing your mental ability to solve random games and giving some Interesting Knockoff tasks.

All three rounds involved in the event do not demand much of technical skills, but they do test thinking and logical abilities.

Date & Time:

03/03/2021 12:00 pm to 8:00 pm

04/03/2021 11:50 Am - 1:00 Pm

No. of Participants: 208

Faculty Committee/Jury: Mr. J Shiva Sai,Smt Madhurima Rana

Winners:

Prize1: Dhruva Indavarapa CSE and Sreenidhi Institute of Science and Technology

Prize2:Yalla Sathwick Reddy CSE CBIT

Links:<https://drive.google.com/drive/folders/1xqa8X4YeYmADIBm7LhH4J2byIvleES8X?usp=sharing>

(Handwritten Signature)
 Principal
 Chaitanya Bharathi Institute of Technology
 (Autonomous)
 Gandipet, Hyderabad-500 075.



Photos:



S.No.	Event Name	No. of Participants	No. of Outside Participants
1	Technical Paper Presentation	11	26
2	Technical Poster Presentation	9	1
3	Technical Project/Prototype Presentation	17	5
4	Technical Online Quiz- Fast and Furious	154	25
5	Kodecrypt	190	
6	Bug Beaters	74	6
7	DESIGN FREAKS	113	35
8	Data Addicts	109	08

P. A. ...
Principal



9	C-Star	213	18
10	Tic Tech Toe	104	10
11	Find Fit Finish	208	22

Headstart 2021 Poster

EVENTS:

- C STAR
- BUGBEATERS
- DESIGN FREAKS
- FIND FIT FINISH
- PAPER PRESENTATION
- POSTER PRESENTATION

SUDHIEE 2K21
Department of Computer Science and Engineering
Presents
HEADSTART 2K21
-Transcending Innovations
(Online Event)
MARCH 3rd - 4th
No Registration Fee!!

EVENTS:

- KODECRYPT </>
- TIC TECH TOE
- DATA ADDICTS
- FAST & FURIOUS
- PROJECT PRESENTATION

Faculty Coordinators:
P.Vimala Manohara Ruth – 9849653963
Ch. Madhavi Sudha – 7893131817

Student Coordinators:
Y. Sairakshitha – 9966142099
Dora Sai Varma E – 8333941245
D. Harshavardhan – 8919507039

For more information visit:
HEADSTART.CBIT.ORG.IN

Valedictory Ceremony

The Valedictory Ceremony of Headstart, was conducted online at 03:35 PM on 4th March, 2021. The ceremony was presided over by the Head of the Department of CSE, Professors, faculty members and the Guest Speaker. The number of registrations for each event were announced. The speaker, Mr. Surya Putchala, CEO and Founder, ZettaMine Labs, then addressed the crowd. The Winners and number of registrations per event were announced. The program ended with vote of thanks.

Headstart 2021 Valedictory Ceremony

Date & Time:

04-03-2021 03:45 PM to 04:15 PM

Speaker: Mr. Surya Putchala

Topic: Career Oppuritunities



(Handwritten signature)

Principal

Chaitanya Bharathi Institute of Technology

(Autonomous)

Gandipet, Hyderabad-500 075.

Audience: 74

Links:

https://drive.google.com/file/d/1_YxvGvSuBz8L.VZft1DaD9xw-YrdRO31l/view?usp=sharing

Photos:

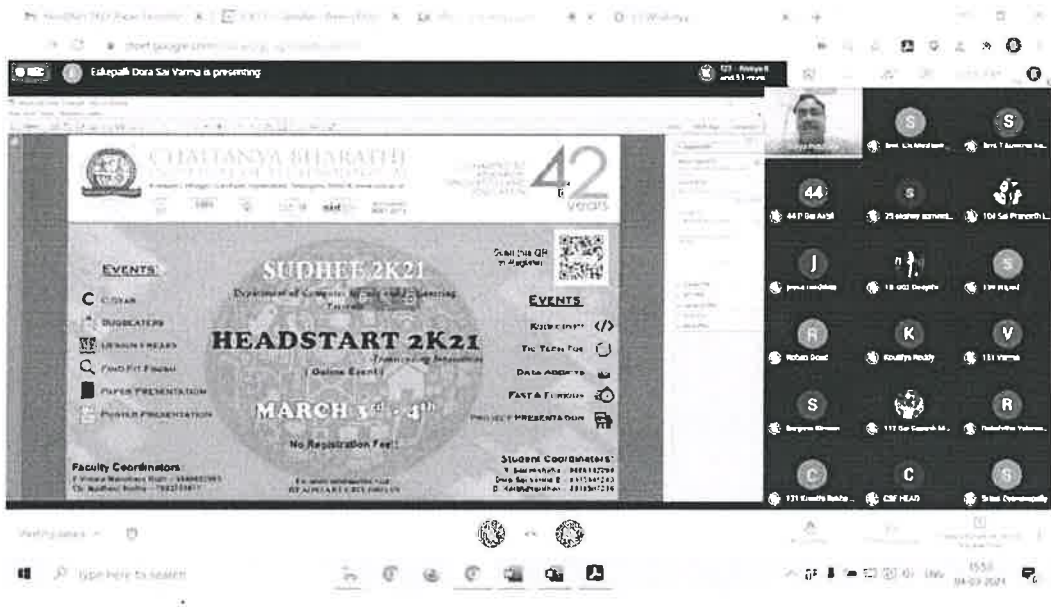

Pre-Event Headstart 2021

The Pre-Event of Headstart 2021 entitled “Web Development” was conducted in association with CBIT Open-Source Community (COSC) on 21st February, 2021 from 10:00 AM to 04:00 PM Online.

Speakers and Secretary

1. HTML Speaker - Club Secretary - Sanjeev
2. CSS Speaker - Vice President - Komali
3. JAVASCRIPT Speaker - Joint Secretary - Sourabh
4. DOM-Joint Secretary - Sowmya
5. Hands on Project - Student Coordinator and President - Khush Jain

Principal
Chaitanya Bharathi Institute of Technology
(Autonomous)
Gandipet, Hyderabad-500 075.



The schedule for the event was as follows:

Start Time	End Time	Duration	Session
10:00 AM	10:03AM	3 mins	COSC Introduction
10:03 AM	10:05 AM	2 mins	CSE HOD
10:05 AM	10:07 AM	2 mins	IT HOD
10:10 AM	11:20 AM	10 mins	HTML
11:20 AM	12:30PM	1 Hr 10mins	CSS
12:30 PM	1:00PM:	30 mins	Lunch
1: 00 PM	2:10 PM	1 hr 10 mins	JavaScript
2:10 PM	3:00 PM	45mins	Hands on Project (ToDo App)
3:00 PM	3:30 PM	30 mins	Kahoot Quiz (3 quiz)
3:30 PM	3:45 PM	15 mins	One of Sudhee member talked about sudhee
3:45PM	-	-	END OF EVENT

Demographics

The demographics for the event are as follows:

1. 23 other colleges have registrations like SVIET, Sree Venkateswara College of Engineering, Miranda house Delhi University, BVRIT, Sri Sivani College of Engineering, SVCE, Stanley college of Engineering, Nigama engineering college, Anurag University, Nalla Narsimha Reddy, RMD engineering college.

2. Total registrations for the Pre-Event were 186.

Vote of Thanks

We would like to thank CBIT Management, Principal, Head of CSE Department and all Teaching and Non-Teaching Staff of CSE Department of their help and support. We would

Principal
 Chaitanya Bharathi Institute of Technology
 (Autonomous)
 Gandipet, Hyderabad-500 075.



also like to thank our speakers who gave the participants, the much-needed boost and their valuable guidance. We congratulate all the winners and all the participants.



Principal
Chaitanya Bharathi Institute of Technology
(Autonomous)
Gandipet, Hyderabad-500 075.

Principal
Chaitanya Bharathi Institute of Technology
(Autonomous)
Gandipet, Hyderabad-500 075.



CIVILIZATIONS 2021 REPORT

Day1: 03 March 2021

The Department of Civil Engineering organised a two day technical event “CIVILIZATIONS 2021” on 3 March and 4 March 2021 in the online mode. The events organised on the first day, i.e. 3rd March 2021 are Paper Presentation, Hangman, Poster Presentation, and Techno Quiz. The second day, i.e. 4th March 2021 events are a one-day workshop on STAAD PRO, Paper Presentation, Model Expo, Techno Quiz and Hangman.

INAUGURAL SESSION 11:30 AM TO 12:45 PM

The inaugural speech for the theme of “Digital Innovations in the 21st century” was delivered by Er. M.V. Srinivas, Chief Engineer, Krishna Godavari Basin Organisation, Central Water Commission.

He started the session with a comparison between a slide scale, which was used in olden days, and a scientific calculator used by the students nowadays. Using this, he explained the accuracy and speed brought by the digital technology for calculations of volumes and high water levels used for the purpose of water level determination. The talk focussed on the applications of digital innovations in the estimation of water levels in the reservoirs of rivers Godavari and Krishna. The various formulae which were used for the estimation of the total volume of water in the rivers is explained starting from the Khosla formula to the current real time data collection procedures using satellites. A few digital innovations like remote sensing and Geographical Information Systems (GIS) were used in forecasting the water levels and flood water levels in the river basins of Godavari and Krishna rivers. Various details related to the real world data collection, calculation of water levels and required volume of water for irrigation were explained by using various examples from the real world. It was followed by the question and answer session with enthusiastic participation of the students. The total number of students is around 120 for the session.

The following four events, namely Paper Presentation/Idea Presentation, Poster Presentation, Techno Quiz and Hangman were organised simultaneously from 2:00 pm onwards.

Paper and Idea Presentation was conducted on both the days.

A total of 16 teams participated, of which 5 were from Tamil Nadu, one team from CMRIT, Telangana, and 10 were in house teams.



Principal
Chaitanya Bharathi Institute of Technology
(Autonomous)
Gandipet, Hyderabad-500 075.



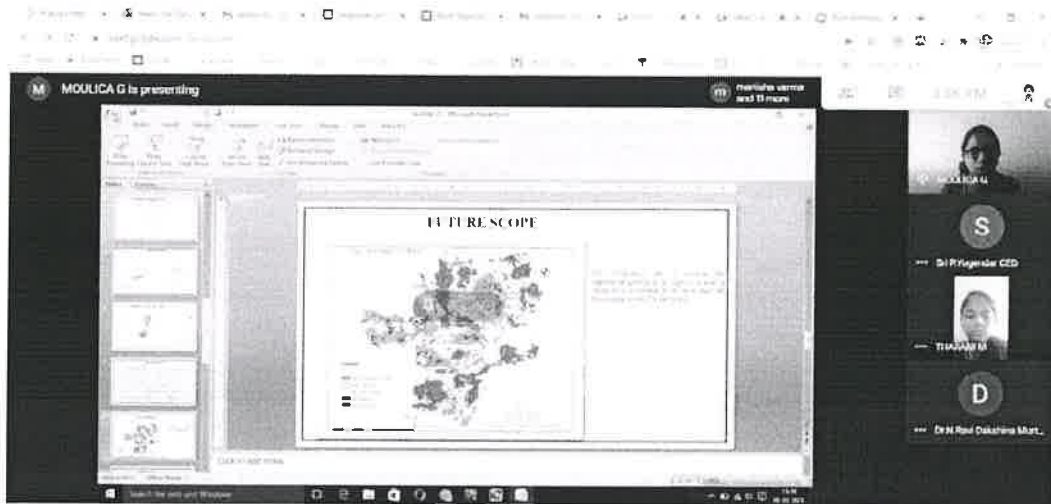

(Handwritten signature in green ink)

Principal
Chaitanya Bharathi Institute of Technology
(Autonomous)
Gandipet, Hyderabad-500 075.



Poster presentation from 2:00 pm to 4:30 pm on 3 March 2021

The total participants for this event were 8 of whom 7 were in house participants.



Hangman from 2:00 pm to 4:30 pm

This event consisted of guessing the right civil engineering terms and a few words from the English vocabulary with the help of given hints. The participants for this event were 15 with exactly 13 in house participants.

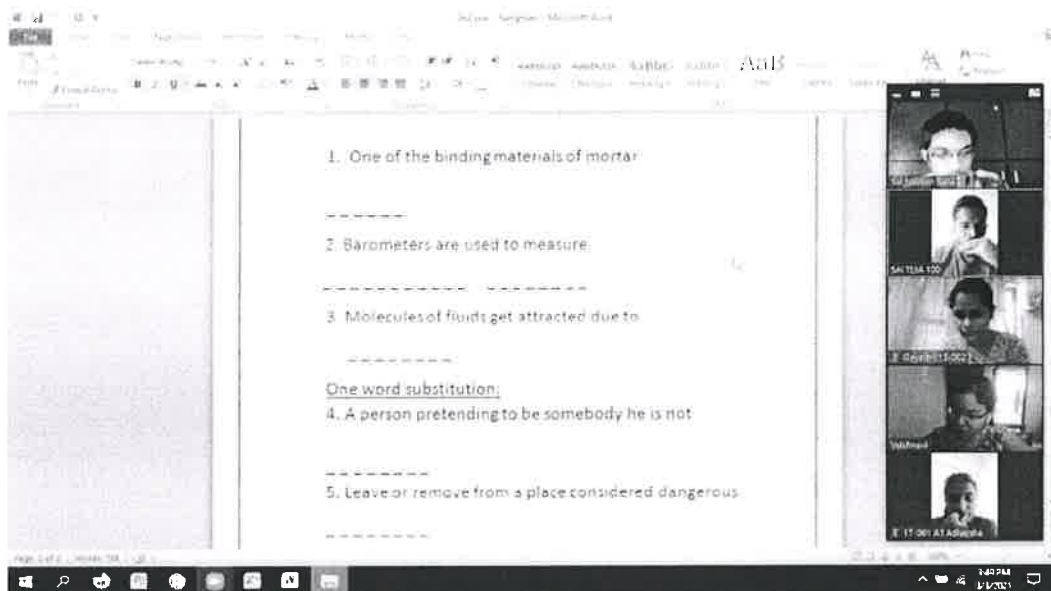

Techno quiz from 2:00 pm to 4:30 pm

The participants are quizzed on various civil engineering and related fields focussing on the real world applications of civil engineering. The participants for this event are 38 with 38 in

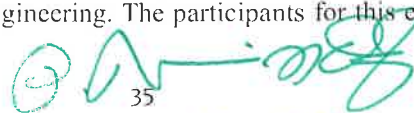
35

Principal
Chaitanya Bharathi Institute of Technology
(Autonomous)
Gandipet, Hyderabad-500 075.

house participants.



Day2: 4th March 2021 from 10:00 am to 4:30 pm

Workshop on the applications of STAAD PRO software by Mr. Saravanan, Chief design Engineer, Bentley Systems, Hyderabad. The various aspects of STAAD PRO namely the basic commands, load distribution, beam length and detailing were explained in this workshop by the expert of this area. The concepts were explained from the basics keeping in view the students mix from first year to that of final year. The workshop witnessed an enthusiastic participation of 38 participants including 37 in house participants.

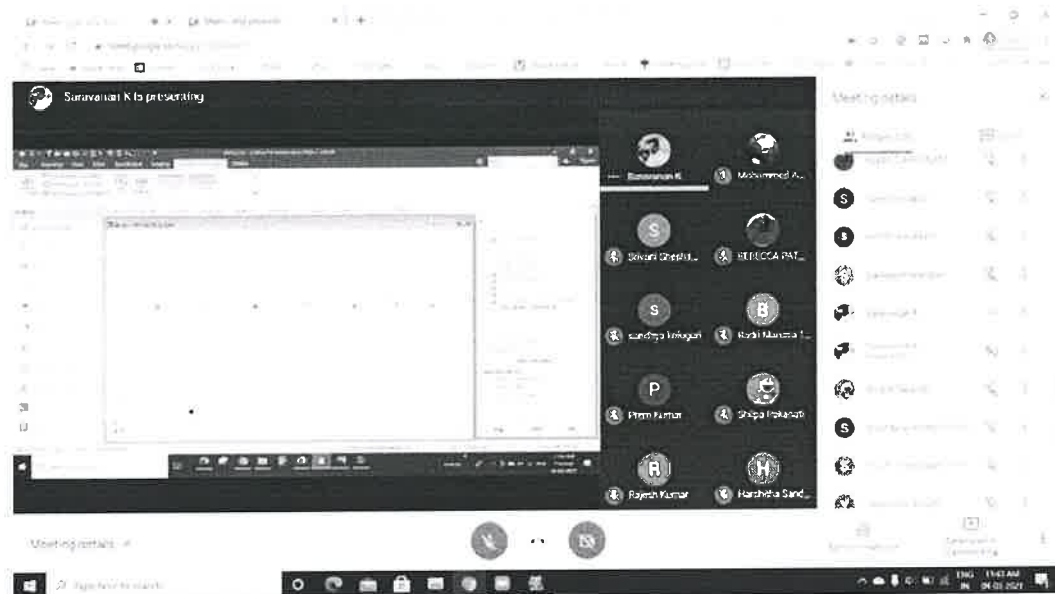

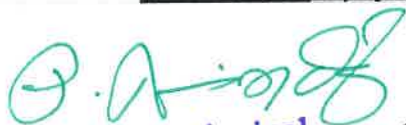
Principal³⁶
Chaitanya Bharathi Institute of Technology
(Autonomous)
Gandipet, Hyderabad-500 075.



Model Expo from 10:30 am to 11:30 am

The model expo event was organised in the virtual mode and had three teams participating in it including two teams from outside CBIT. The first team consisted of two 3rd year civil engineering students namely Ms. Poornima and Mr. Sridhar from Bannari Amman College of Engineering and Technology from Tamil Nadu. They presented a not to scale version of the Golden Gate bridge with details about its making, materials used and its concept. The second team consisted of one student Mr. P. Karthik, final year student of CED, CBIT. He explained the concept of permaculture as an alternative to the current intensive agriculture practices explaining the benefits and also the importance of this farming. The third team had two students of 3rd year civil engineering namely Mr. Udhaya Kumar and Mr. Naveen who explained the features of Tied Arch bridge using a not to scale version of the same. Each of the teams have answered a set of queries related to their models.



Bridge the Gap from 10.30 am to 12.00 pm

The Bridge the Gap event was organised to test the problem solving skills of the students. In this event, the participants were required to suggest a solution for the displayed real-life problems. The solutions given by the participants were judged based on the feasibility, sustainability and cost-effectiveness. There were a total of 15 participants out of which 1 was from MGIT, 3 were from Tamil Nadu and the rest of them were from CBIT.

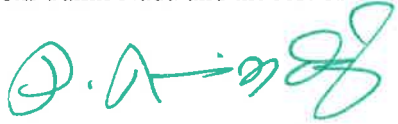
Principal
Chaitanya Bharathi Institute of Technology
(Autonomous)
Gandipet, Hyderabad-500 075.





Hangman from 10:30 am to 12.30 pm

Hangman was conducted on 4th March for the remaining participants. Also a second round was conducted for the students who performed well in the first round. 9 students were selected for round 2, which consisted of guessing a few civil engineering terminologies in the shortest time.



(Handwritten signature in green ink)

Principal
Chaitanya Bharathi Institute of Technology
(Autonomous)
Gandipet, Hyderabad-500 075.



ELECTRET - 2021

To
The Principal
CBIT

Respected Sir,

Sub: Report- 'ELECTRET FEST'(Online Mode)- EEE Department- 03rd&4th March 2021-
Reg..

The 'ELECTRET FEST' (Online) of EEE Department has been conducted on 03rd & 04th March 2021 as part of the Institute Technical Fest., SUDHEE 2021. The Faculty coordinators for this event are D.Harsha & Dr.N.V Phanendra Babu.

The Department 'ELECTRET Fest' was started at 12:15PM in online mode using Google-meet platform. Dr.G.Suresh Babu , Professor and HoD of EEE, welcomed the Teaching , Non-Teaching Staff, Students & Participants from the various institutes to this online virtual meeting.

The B.E. Student Kshihitiessh Bharadwaj asked our HoD to throw some light regarding our departmental Fest. 'ELECTRET'. After the address by HoD, the brief profile of our key note speaker Mr. N Sudhanshu Naithani, GM, CDT, New Delhi was read by our student Kshihiteiessh Bharadwaj. Then, the key note speaker has addressed the gathering on the topic 'Digital Transformations in Machine Manufacturing' which is in line with the theme of institute fest 'SUDHEE'.

Sir has clearly explained about how fast the changes are happening in industry i.e., from Conventional to Digital transformation. The session has been concluded at 01:30PM by giving our vote of thanks to the keynote speaker for sharing his practical insights that are happening in industries. The number of participants attended this key note lecture was 50. After that, the following eleven (11) events in our 'ELECTRET FEST' were conducted in an online mode, by our student organizers, till evening 05:30PM (DAY-1)

S. No.	Name of the Event
1.	Levitation
2.	Idea Presentation
3.	Electruzzle
4.	Electrocache
5.	E-concorrenza
6.	Electrospell



Principal

Chaitanya Bharathi Institute of Technology
(Autonomous)
Gandhinagar, Hyderabad-500 075.



7.	Electro bliss
8.	Sparkz 'eee'
9.	Funectron
10.	Coding
11.	Inventrix

As the registrations received were huge in number, Some the events were also conducted on the 4th March, 2021. The total number of registrations received for the various events conducted in our departmental fest (ELECTRET) is 496. The participants were also from other states such as Andhra Pradesh , Tamil Nadu , Goa, etc... All the events have been completed by 03:00 PM on 4th March 2021. The valedictory started at 03:30PM on Google-Meet platform. Dr .K.Krishnaveni, Professor, Director Academics, and Dr. M. Balasubba Reddy, Associate Professor, addressed all the Faculty, Participants, Student Coordinators, Student Organizers and Volunteers regarding this ELECTRET Fest. Mr. T.Maniver Reddy, Student Coordinator, has given a detailed report on the two days technical fest (ELECTRET). The student Participant Akshitha gave her valuable feedback about all the events. The Faculty Coordinator, D.Harsha & Dr. N. V Phanendra Babu have congratulated Ummay Salma for her poster which is being selected as the Best Sudhee poster at the Institute level. The Faculty coordinators D. Harsha & Dr.N.V Phanendra Babu Congratulated Teaching Staff , Non - teaching staff, Student Coordinators, Student Organizers, Volunteers for making this event Grand success with huge number of registrations though it was conducted in an Online mode, for the first time . The Faculty coordinators thank HoD for giving them opportunity to be the coordinators for this event. The event was moderated by the B.E student kshiteish Bharadwaj. At the end, Mr. B.Mahesh Reddy has Proposed Vote of thanks for this event.

Thank you Sir.

Faculty Coorinator

D.HARSHA

Dr.N.V Phanendra Babu

HoD

Principal
 Chaitanya Bharathi Institute of Technology
 (Autonomous)
 Gandipet, Hyderabad-500 075.





CHAITANYA BHARATHI
INSTITUTE OF TECHNOLOGY (A)

Kokapet (Village), Gandipol, Hyderabad, Telangana-500075. www.cbit.ac.in



COMMITTED TO
RESEARCH,
INNOVATION AND
EDUCATION

42
years

Sudhee 2021

Department of Mechanical Engineering

Mechanica 2021

About Mechanica

Mechanica is the two-day National-Level Technical Fest of Department of Mechanical Engineering organized as a part of Sudhee 2021, the Technical Fest of CBIT. Mechanica has organized 7 ecstatic events during the year 2020-2021. The fest was conducted on the 3rd and 4th of March, 2021 virtually. We had **237** participants altogether.

Support from College

The College Management, Principal, Sudhee Core Committee, Head of the Department have encouraged, supported and guided us in this endeavor.

Faculty Coordinators:

1. Dr. S. Solomon Raj, Associate Professor



2. Sri. P. Kiran Kumar, Assistant. Professor



Student Coordinators:

1. Vignan Babu. D



Principal
Chaitanya Bharathi Institute of Technology
(Autonomous)
Gandipet, Hyderabad-500 075.



2. Kaleemullah. M



3. Dheeraj. N



DETAILS ABOUT THE EVENT

Inaugural Ceremony

The Opening Ceremony of Mechanics, was conducted online at 11:30 AM on 3rd March, 2021. The ceremony was presided over by the Head of the Department, Mechanical Engineering, Professors, faculty Coordinators and faculty members. The speaker, Dr.L.Siva Rama Krishna, then addressed the crowd. The conference was officially declared open.

Speaker: Dr. L.Siva Rama Krishna

Topic: Innovative Application of 3D printing

Event Dates: 3rd and 4th March 2021

Event Website: [HOME | Mechanics2021 \(wixsite.com\)](http://HOME | Mechanics2021 (wixsite.com))

A handwritten signature in green ink, likely belonging to the Principal.

Principal
Chaitanya Bharathi Institute of Technology
(Autonomous)
Gandipet, Hyderabad-500 075.



Guest Speaker



**Dr. L. Siva Rama
Krishna.**
**Associate Professor
MED, OUCE.**

Profile:

Dr. L. Siva Rama Krishna, is presently working as Associate Professor in the Dept. of Mech. Engineering, University College of Engineering(A), Osmania University. Presently he is **working as Joint Director, Centre for Product Design, Development and Additive Manufacturing (A centre of Excellence established under RUSA 2.0)**, Nodal Officer PMSSS (J&K), Single Point of Contact for Local Chapter SWAYAM- NPTEL, NSS program officer, and Faculty Adviser for M.E course on DFM. Course. He has also worked as Joint Director of Evaluation Examination Cell, University College of Engineering, Osmania University.

Some Professional milestones:

He is Reviewer for many reputed journals like Institute of Engineers India Series C journal Springer Series, British Journal of Medicine and Medical Research, etc. He has won the best research paper award in the International Conference on Recent Innovations in Engineering and Technology at Bhubaneswar. He has guided more than 60 ME projects and presently guiding 9 Ph.D students. He has delivered 85 guest lecturers in various UGC & AICTE refresher courses, webinars, in house training programs of prestigious organizations like BHEL (R&D), BDL etc. He has also organized various STTP's, International Conferences, workshops etc. He works with **MDS Care Hospitals Banjara Hills, Yashodha Hospitals Secunderabad and Sri Sai Dental College, Mahbubnagr for solving various critical cases related Cranioplasty and Maxillofacial Surgeries.**

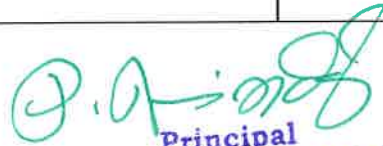
Principal
Chaitanya Bharathi Institute of Technology
(Autonomous)
Gandipet, Hyderabad-500 075.



The schedule for the event was as follows:

Mechanica 2021 Inaugural Function

Date & Time:

03-03-2021 11:30 AM to 11:45 AM

Event 1: Guest Talk

Date & Time :

03-03-2021 11:45 AM – 01 : 15 PM

Speaker: Dr. L. Siva Rama Krishna

Topic: Innovative Application of 3D printing

Audience: 50 Count

Event Description :

To uphold the enthusiasm and excitement of the students in emerging technologies in the field of Mechanical Engineering. We have come up with an industrial expert who will explain the scope of their studies in practical applications

The event will help the students to choose their career path by exercising every step, in relation to the future demanding skills.

Links:

<https://drive.google.com/file/d/184dIDyPqsufOK58KXe6ZygiN-C4GtiEJ/view?usp=sharing>

Photos:



Principal
Chaitanya Bharathi Institute of Technology
(Autonomous)
Gandipet, Hyderabad-500 075.





DEPARTMENT OF MECHANICAL ENGINEERING

MECHANICA 2021

Guest Talk



Dr. L. SIVA RAMA KRISHNA
 DR. MFG 0001
 INNOVATIVE APPLICATIONS OF 3D PRINTING

+42

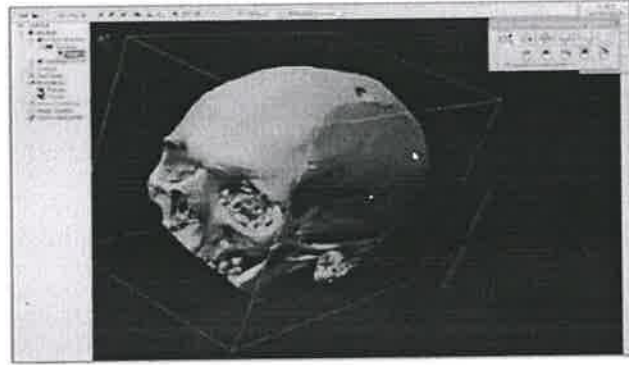

visualization of 3D Model of the Skull attached with Implant

+46

NATIONAL LEVEL STUDENT TECHFEST
 "MECHANICA"
 Organized by
 Dept of Mech. Engg., CBIT Hyderabad
 (03-04, March 2021)

INNOVATIVE APPLICATIONS OF
 3D PRINTING



By
 Dr. L. SIVA RAMA KRISHNA
 Joint Director CPDDAM
 Associate Professor
 Dept. of Mechanical Engg.
 University College of Engg.
 Osmania University

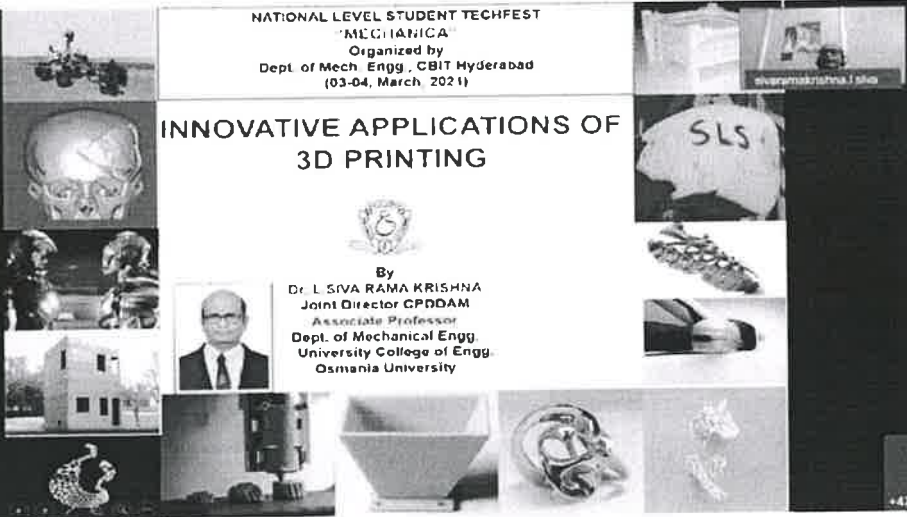

+47

P. A. Singh
 Principal

Chaitanya Bharathi Institute of Technology
 (Autonomous)
 Gandipet, Hyderabad-500 075.



Event 2: Paper Presentation

Event Description:

It is the platform to vent your ideas in the form of well-integrated and intriguing presentation. It gives a unique opportunity to the youngsters to express and compete in the presence of jury. There are two stages in this event where in the first stage is submission of abstract and the next one is the final round where students must present in front of judges. Evaluation is done by highly qualified judges.

Date and Time:

03-03-2021 : 1:30 PM - 03:30 PM

04-03-2021 : 10:30AM - 01:30PM

No. of Participants: 23

Faculty Committee/Jury:

Day 1

Dr. N. V. Srinivasulu

Dr. N. Janardhan

Day 2

Dr. K. Gurubramham

Dr. G Laxmaih

Winners:

Prize-1 : KONAGALLA MANIKANTA, Department of Mechanical Engineering, SASI INSTITUTE OF TECHNOLOGY AND ENGINEERING.

Prize-2 : Rohit Rahul Godse & Suyog Sharnagat, Department of Mechanical Engineering, CBIT

Links:

https://drive.google.com/file/d/1vhaOfO_j0NGVry4UTZdoVA621AozJLKJ/view?usp=sharing

https://drive.google.com/file/d/1cZSbbIA4tVjZztblrA6-Y-4_CoeIXk_t/view?usp=sharing

https://drive.google.com/file/d/1z-oWCYIR5NQ7oISUgCWrrpGq_R0O8aTk/view?usp=sharing

<https://drive.google.com/file/d/18MJORxfwE1-NPY13FJ5G3zSjofdU9rtK/view?usp=sharing>

<https://drive.google.com/file/d/1SBWWB6AjDqVm-W9JiLZArrpZdgxBCq66/view?usp=sharing>

Principal

Chaitanya Bharathi Institute of Technology
(Autonomous)
Gandipet, Hyderabad-500 075.



https://drive.google.com/file/d/1-JL0TDyoZX0qrlBxPijMB38bax9_2-Um/view?usp=sharing

<https://drive.google.com/file/d/1zEYqkpIQGTajoGiWfaXvL99uulu4nTI3/view?usp=sharing>

Photos:

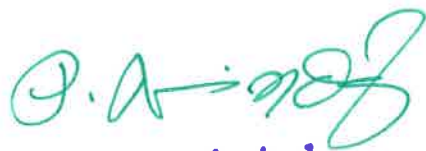
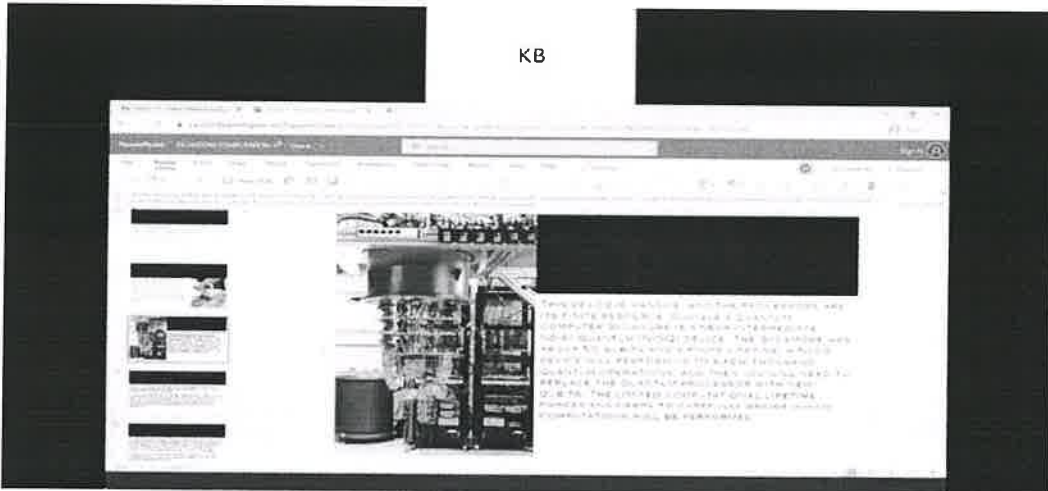

Principal

**Chaitanya Bharathi Institute of Technology
(Autonomous)
Gandipet, Hyderabad-500 075.**



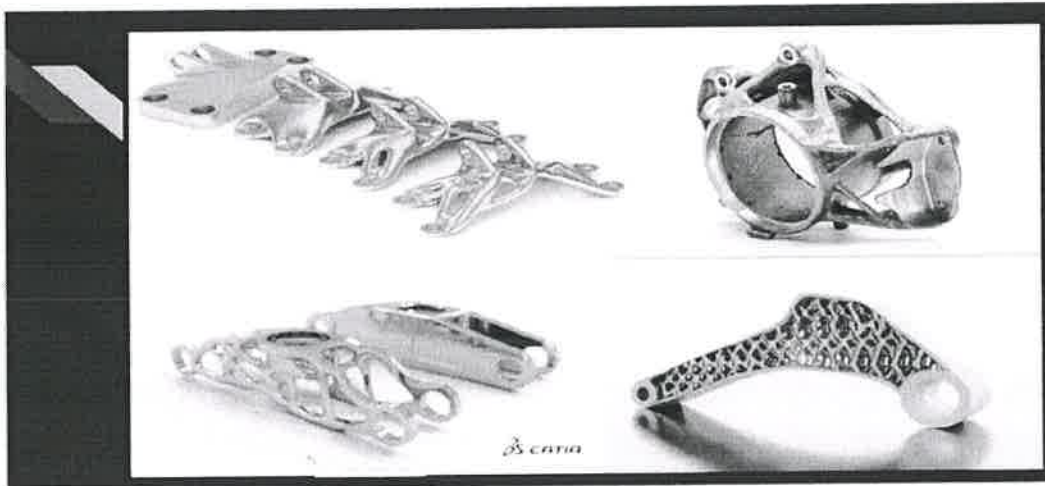



SP

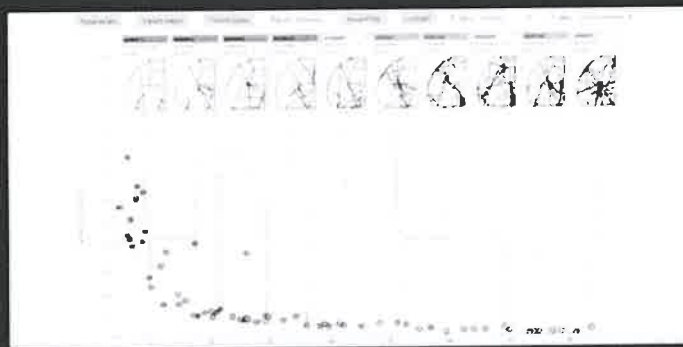

RG



 Principal 48
 Chaitanya Bharathi Institute of Technology
 (Autonomous)
 Gandipet, Hyderabad-500 075.



Event 3 : Quiz

Event Description: Quiz competition is a pursuit of trivial Knowledge, encouraging students to achieve academic excellence and Increase their awareness of the world around them. There are two rounds, where preliminary round has 10 exciting questions along with Riddles and Fill in the Blanks based on the world of Engineering! Final round includes some Pictionary questions.

Date & Time:

03/03/2021 1:30 PM - 02:30 PM

04/03/2021 11:00AM - 12:00PM & 12:45PM - 01 : 15PM

No. of Participants: 48

Faculty Committee/Jury: NA

Winners:

Prize-1: Baladitya Boddu, Mechanical Engineering. CBIT

Prize-2: GANJI SAI RAM, Mechanical Engineering, CBIT

Links:

<https://drive.google.com/file/d/1rzEZGX2-gLyvRtKsuDyujihPf3L4k8Q2/view?usp=sharing>

<https://drive.google.com/file/d/1OwheKxzOtjJdWp-VEVtheE223kDwnn9t/view?usp=sharing>

Photos:

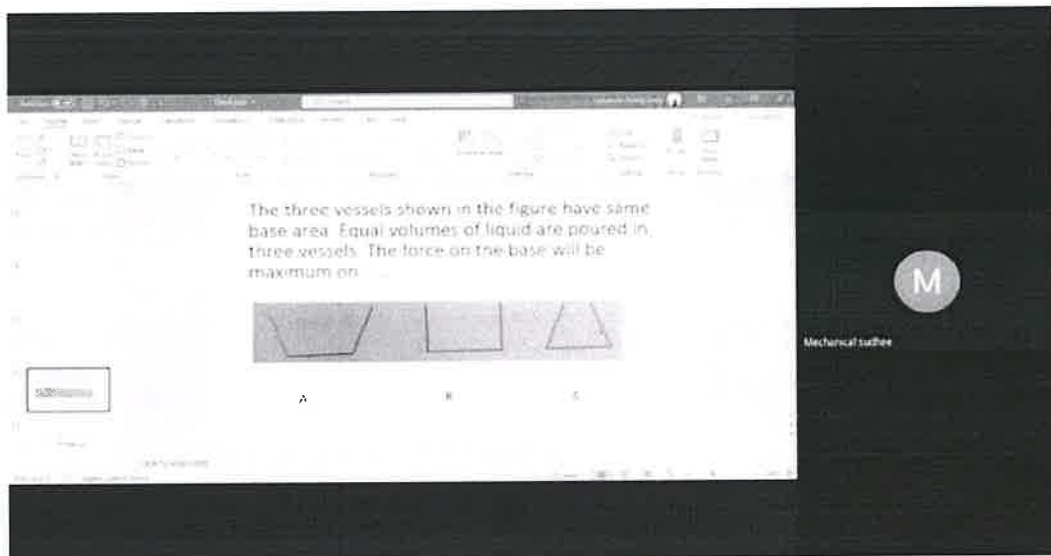



Principal

**Chaitanya Bharathi Institute of Technology
(Autonomous)
Gandipet, Hyderabad-500 075.**

49



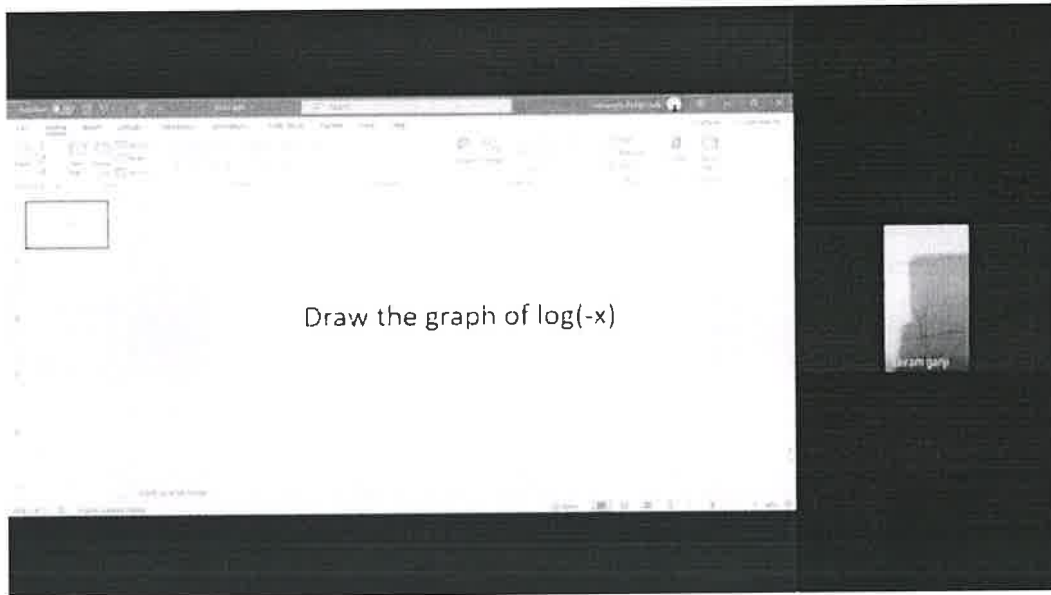
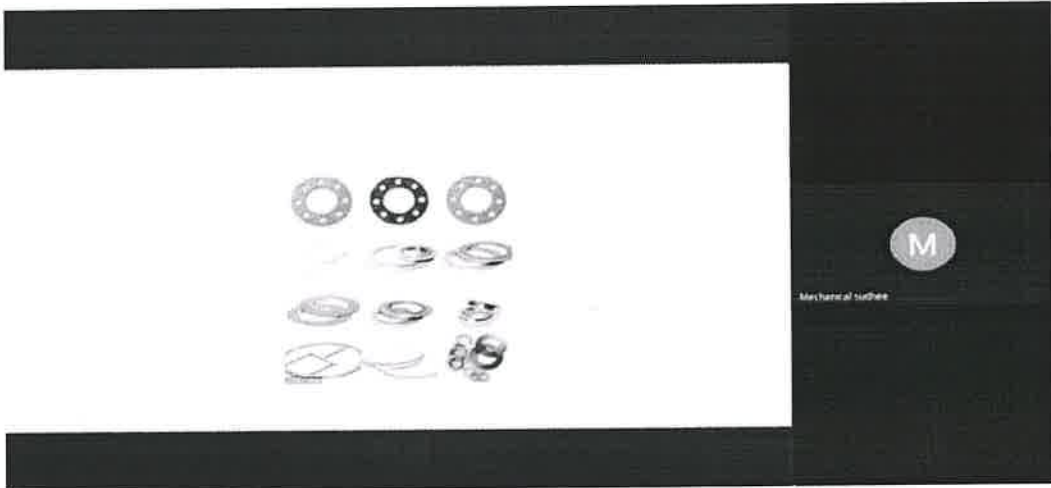

P. A. ...

Principal
Chaitanya Bharathi Institute of Technology
(Autonomous)
Gandipet, Hyderabad-500 075.





What type of heat exchangers do you prefer for less space heating/cooling, why?



Mechanical surface

Handwritten signature in green ink.

51

Principal
Chaitanya Bharathi Institute of Technology
(Autonomous)
Gandipet, Hyderabad-500 075.



Event 4 : Elocution

Event Description

Want to improve your communication skills and become more persuasive when you speak? A stage for lighthearted What If-s and Once upon a time not so long ago-s, we present to you an amazing opportunity to oil your lever of creativity and public speaking. This event consists of three rounds of exponential fun and laughter where content, fluency and vocabulary pedal the enthusiasm in a medium of profound story telling. Six topics will be given to the participants a day before for preparation and a dice is rolled at the time of the contest upon which the participant has to speak.

Time:

04-03-2021 : 11 : 30PM - 12 : 30 PM

No. of Participants: 09

Faculty Committee/Jury: Dr. K. Kishor

Winners:

Prize1: Konagalla Manikanta, Department of Mechanical Engineering, SASI INSTITUTE OF TECHNOLOGY AND ENGINEERING

Prize2: M.S.SAWANTH, Mechanical Engineering, CBIT

Links:

https://drive.google.com/file/d/16bcE97nMizVXYRKJXKlq5EVooeh_PP5-/view?usp=sharing

<https://drive.google.com/file/d/1fvRB0wLRiPPTjzZChXZRV3slPxDoKjZB/view?usp=sharing>

Photos:



(Handwritten signature in green ink)

Principal

**Chaitanya Bharathi Institute of Technology
(Autonomous)
Gandipet, Hyderabad-500 075.**





Event 5: CAD modelling

Event Description:

Here is an amazing opportunity to showcase your skill on a unique and mostly used platform called Computer Aided Designing. It strives to explore the competency of young minds by giving their incredulous ideas a Shape, Form and helps in dynamic analysis of different worldly things.

In this event, the participants have to draw the 2D view of the given 3D Model, given by the organizing team within the stipulated time, which is decided prior to the event. The designs are evaluated based on the precision of design and the time in which the design is submitted.

Date and Time:

03/03/2021 1:30 PM - 02:30 PM



Principal

**Chaitanya Bharathi Institute of Technology
(Autonomous)
Gandipet, Hyderabad-500 075.**

04/03/2021 10:00AM - 01:00PM

No. of Participants: 20

Faculty Committee/Jury: Smt. Ch. Indira Priyadarsini

Winners:

Prize1: Yashwanth K, mechanical Engineering, CBIT

Prize2: Jashwanth Reddy Earla, Mechanical Engineering, CBIT

Links:

https://drive.google.com/file/d/1ayeI-h_I2VjMURQXRkImzSQDjTiCxHyq/view?usp=sharing

<https://drive.google.com/file/d/1ILGdC1K3Zjc8mujjYGDKnE63jzhIIAY/view?usp=sharing>

Photos:

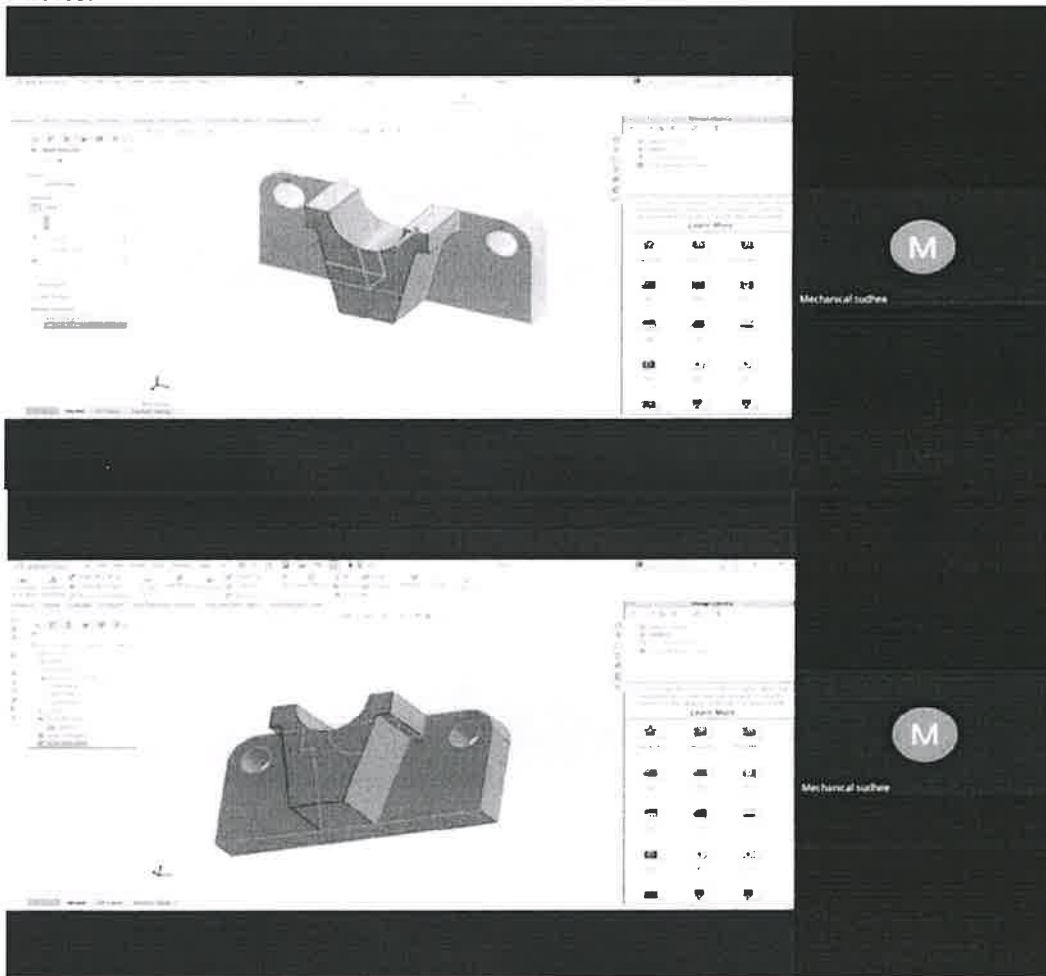

P. A. Indira



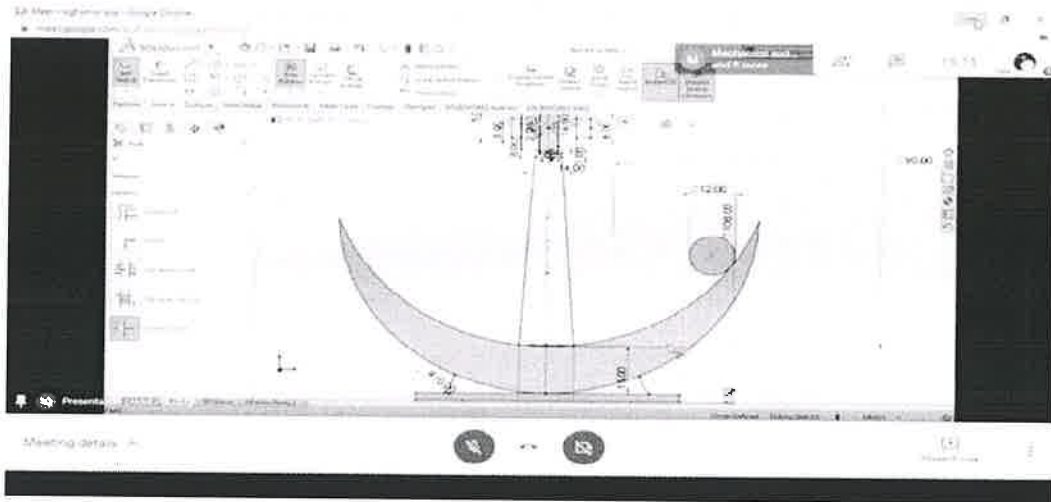

Event 6: Poster Presentation

Event Description:

Poster presentation is the contest which may help one to portray their creativity in relevance to their technical knowledge. Consider it to be same as a paper presentation, poster presentation involves making a digital poster which depicts ones idea and research rather than a Power Point presentation.

There are two stages in this event wherein the first stage involves brief description of their idea and the next being the final round wherein students have to present their posters with enthusiastic explanation to the audience and judges. Evaluation is done by highly qualified judges. The event will be held online

Date and Time:

[Handwritten signature in green ink]



Principal
Chaitanya Bharathi Institute of Technology
(Autonomous)
Gandipet, Hyderabad-500 075.

04/03/2021 : 12 : 30PM - 01 : 30 PM

No. of Participants: 09

Faculty Committee/Jury: Smt. Ch. V. Sushma

Winners:

Prize1: KONAGALLA MANIKANTA, Department of Mechanical Engineering, SASI INSTITUTE OF TECHNOLOGY AND ENGINEERING

Prize2: Satya Sai Kataru, Mechanical Engineering, CBIT.

Links:

https://drive.google.com/file/d/1uvA-jjkAkaKx0CCbZ8w9t9_BZCcPWf7I/view?usp=sharing

Photos:

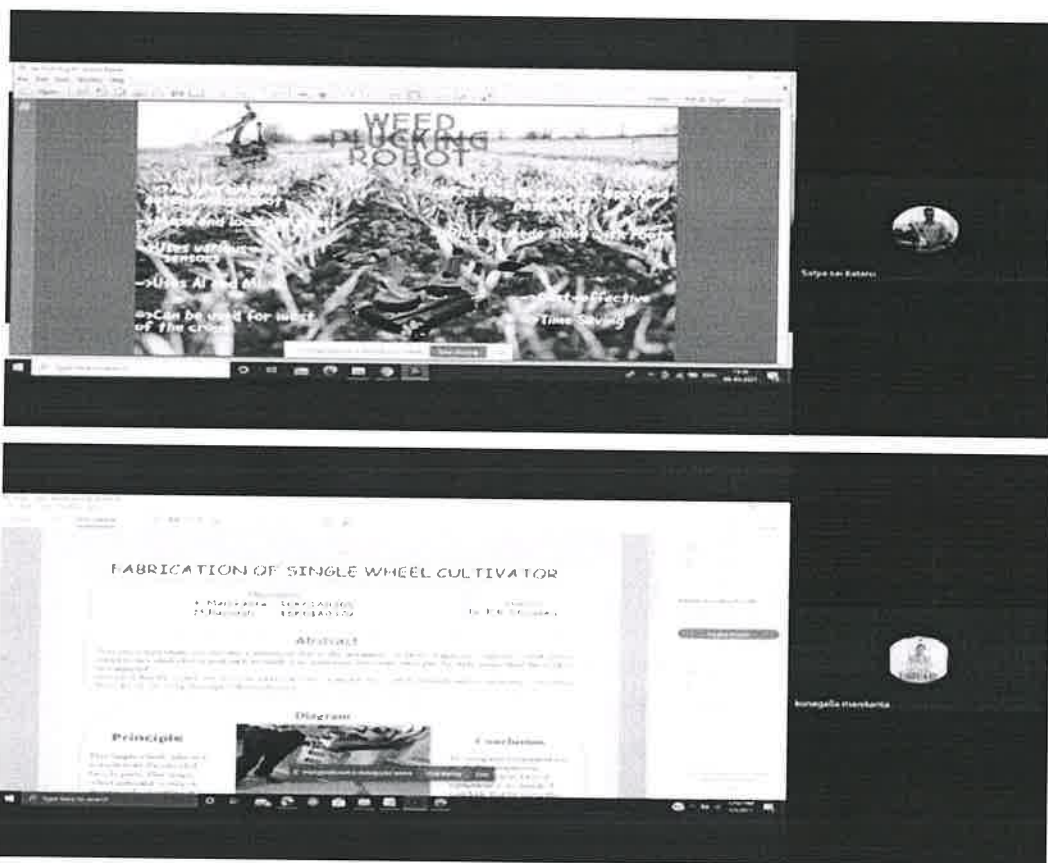

S. A. ...
Principal
Chaitanya Bharathi Institute of Technology
(Autonomous)
Gandipet, Hyderabad-500 075.



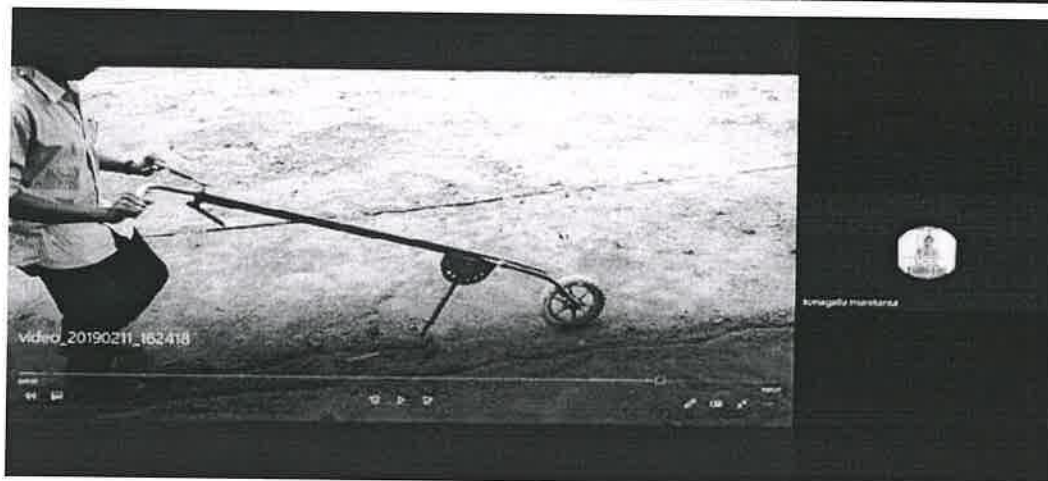
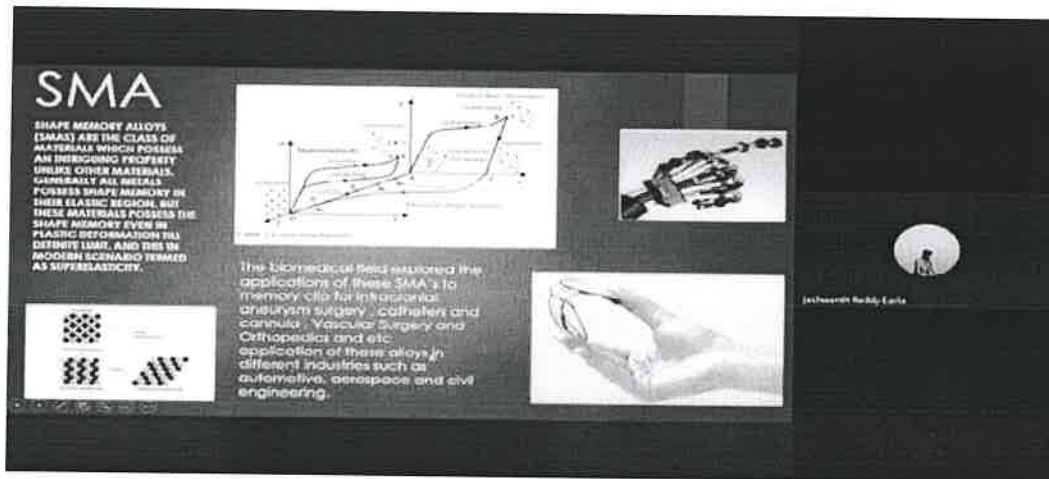

Event 7: Web Design

Event Description:

Our moto of making people multi-talented and making self-reliable has come up come an exciting event in which we made participants to design a website that will help for their startups as a publicity tool, and we hope that our Mechanical engineers will be self-reliable to perform some basic IT tasks

Date & Time:

04/03/2021 10 : 00 AM - 11 : 00 AM

No. of Participants: 08 Teams

(Handwritten signature in green ink)

Principal

**Chaitanya Bharathi Institute of Technology
(Autonomous)**

Gandipet, Hyderabad-500 075.



Faculty Committee/Jury: Smt. Ch. V. Sushma
Winners:

Prize1 : Shravan Jagadam, Mechanical Engineering, CBIT

Prize2 : Vijay Raju, Chemical Engineering, CBIT

Links:

https://drive.google.com/file/d/1c36Lx6DyFB_xGM7ARrdjAljdPtOsJEOp/view?usp=sharing

Photos:

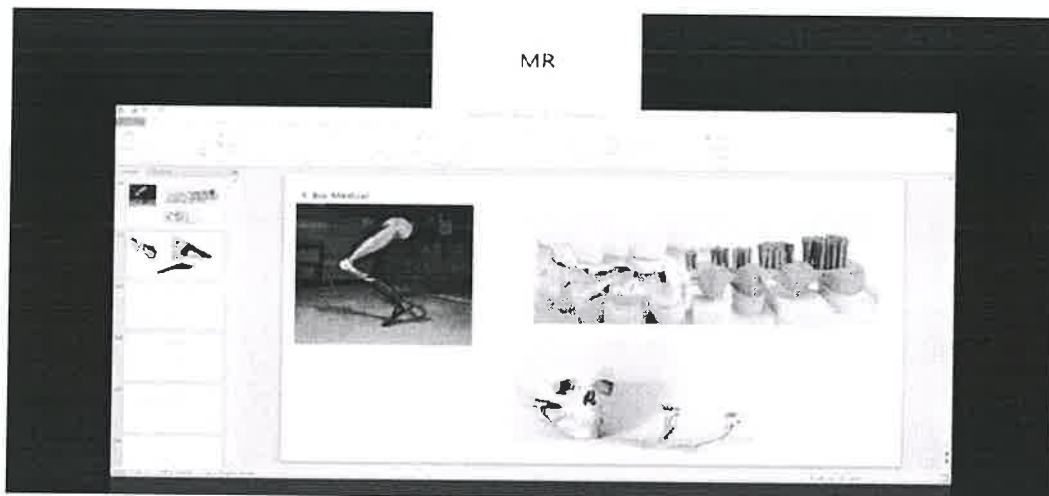
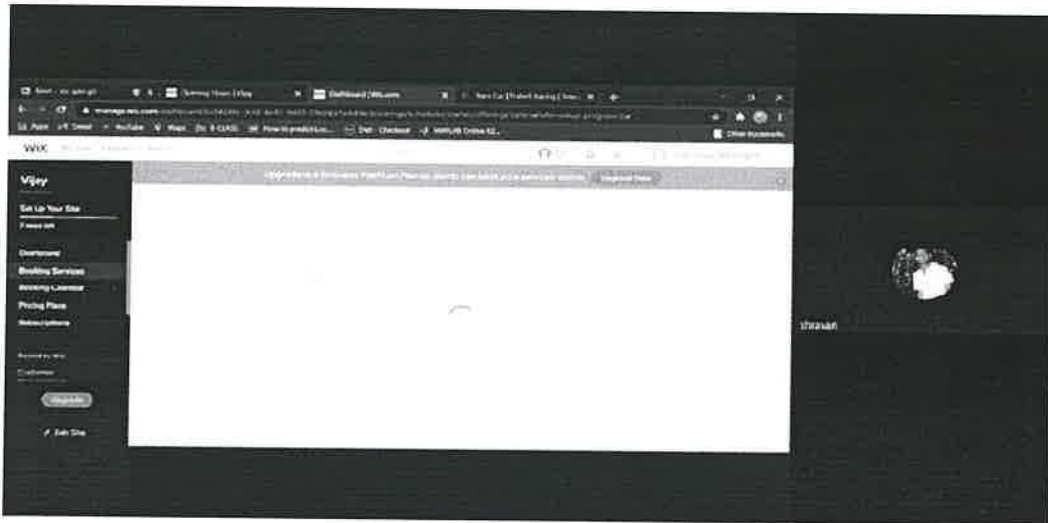

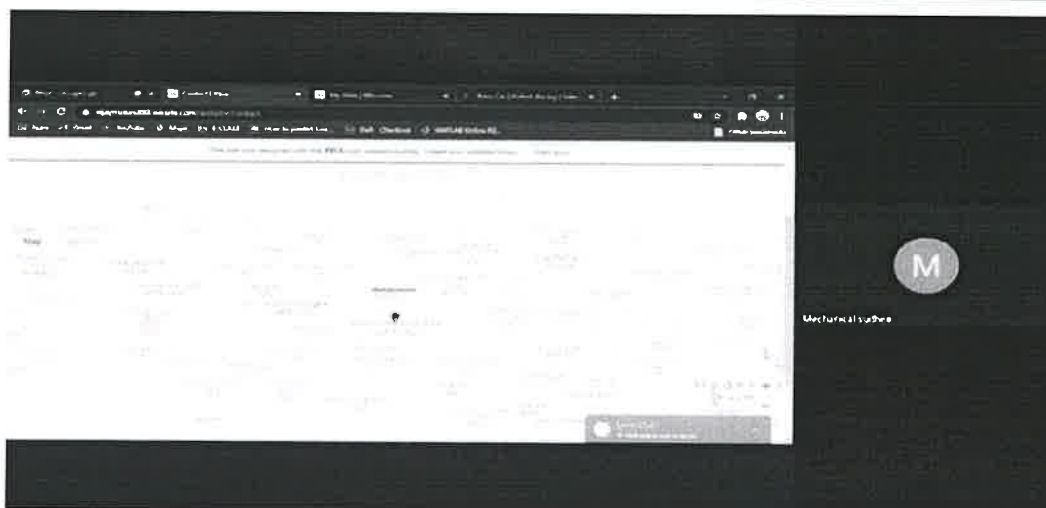
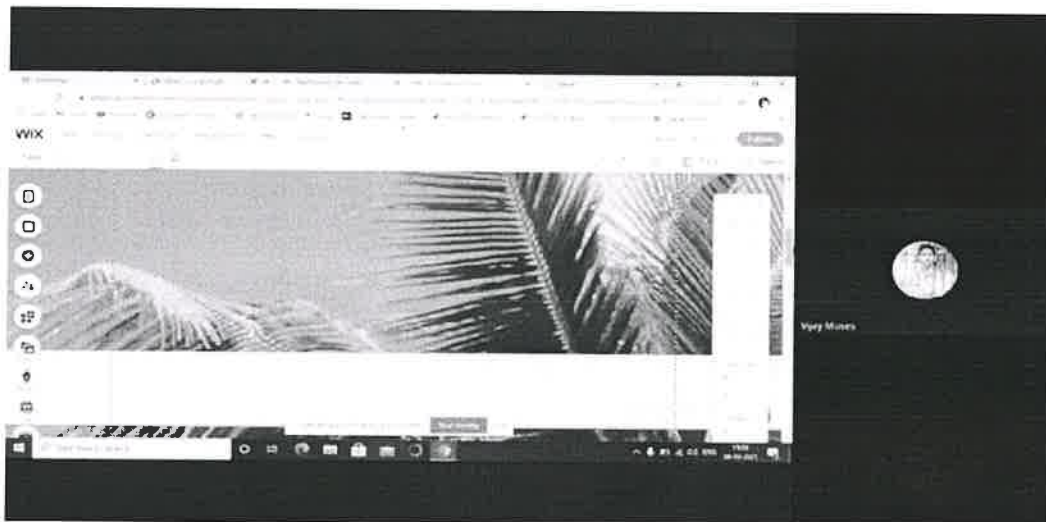

Events Summary :

S.No.	Event Name	No. of Participants (Including Outside Participants)	No. of Outside Participants
1	Paper Presentation	23	04
2	Poster Presentation	09	02
3	Quiz	48	02
4	Elocution	09	01
5	CAD Modelling	20	01



(Handwritten Signature)
Principal
 Chantanya Bharathi Institute of Technology
 (Autonomous)
 Gandipet, Hyderabad-500 075.

6	Web Design	08	01
7	Guest Talk	50	02
8	Valedictory Ceremony	70	00
9	Total	237	13

Mechanica 2021 Poster

CHAITANYA BHARATHI INSTITUTE OF TECHNOLOGY
Kukapet - Village, Gandipet, Hyderabad - Telangana - 500075 - www.cbti.ac.in

COMMITTED TO RESEARCH, INNOVATION AND EDUCATION **42** years

Presents

DEPARTMENT OF MECHANICAL ENGINEERING
MECHANICA

SUDHEE
2k21
NATIONAL LEVEL TECHNICAL SYMPOSIUM

EVENTS :

- PAPER PRESENTATION
- POSTER PRESENTATION
- QUADCOPTER PINNACLE
- CAD MODELLING
- ELOCUTION
- GUEST TALK
- WEB DESIGN
- QUIZ
- AND MUCH MORE FUN

FOLLOW US ON ;

- Facebook: Mechanica2k21
- Email: mechanica_cbit@cbti.ac.in
- Website: mechanica.cbit.wixsite.com/mechanica2021

MARCH 3&4

STUDENT COORDINATORS
Vignan Babu : 9491597061
Kaleemullah : 9700950150
Dheeraj : 9490429916

FACULTY COORDINATORS
Dr.S.Soloman Raj : 9949655133
Sri.P. Kiran Kumar : 9346326852

CHAITANYA BHARATHI INSTITUTE OF TECHNOLOGY (GANDIPET)



P.A. Singh

Principal
Chaitanya Bharathi Institute of Technology
(Autonomous)
Gandipet, Hyderabad-500 075.

Valedictory Ceremony

The Valedictory Ceremony of Mechanical, was conducted online at 03:45 PM on 4th March, 2021. The ceremony was presided over by the Senior Faculty Dr. N.V. Srinivasulu, Professor, MED. The number of registrations for each event were announced. The faculty coordinator Dr. S. Solomon Raj, Sri P. Kiran Kumar then addressed the crowd. The Winners, Runners per event were announced. The program ended with vote of thanks.

Mechanica 2021 Valedictory Ceremony

Date & Time:

04-03-2021 03:45 PM to 04:15 PM

Audience: 70

Links:

https://drive.google.com/file/d/1jQA_tSWbJ8Lez8hfu1prb6va4ZN2wEgh/view?usp=sharing

Photos:

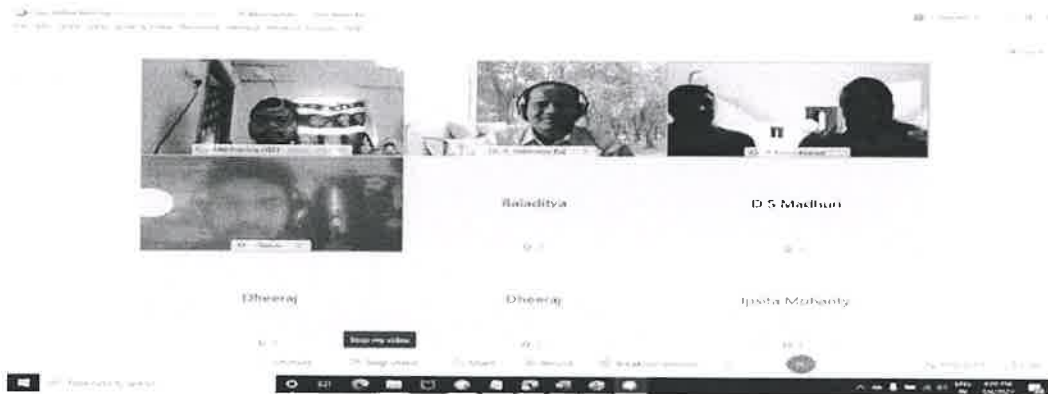

Principal
Chaitanya Bharathi Institute of Technology
(Autonomous)
Gandipet, Hyderabad-500 075.



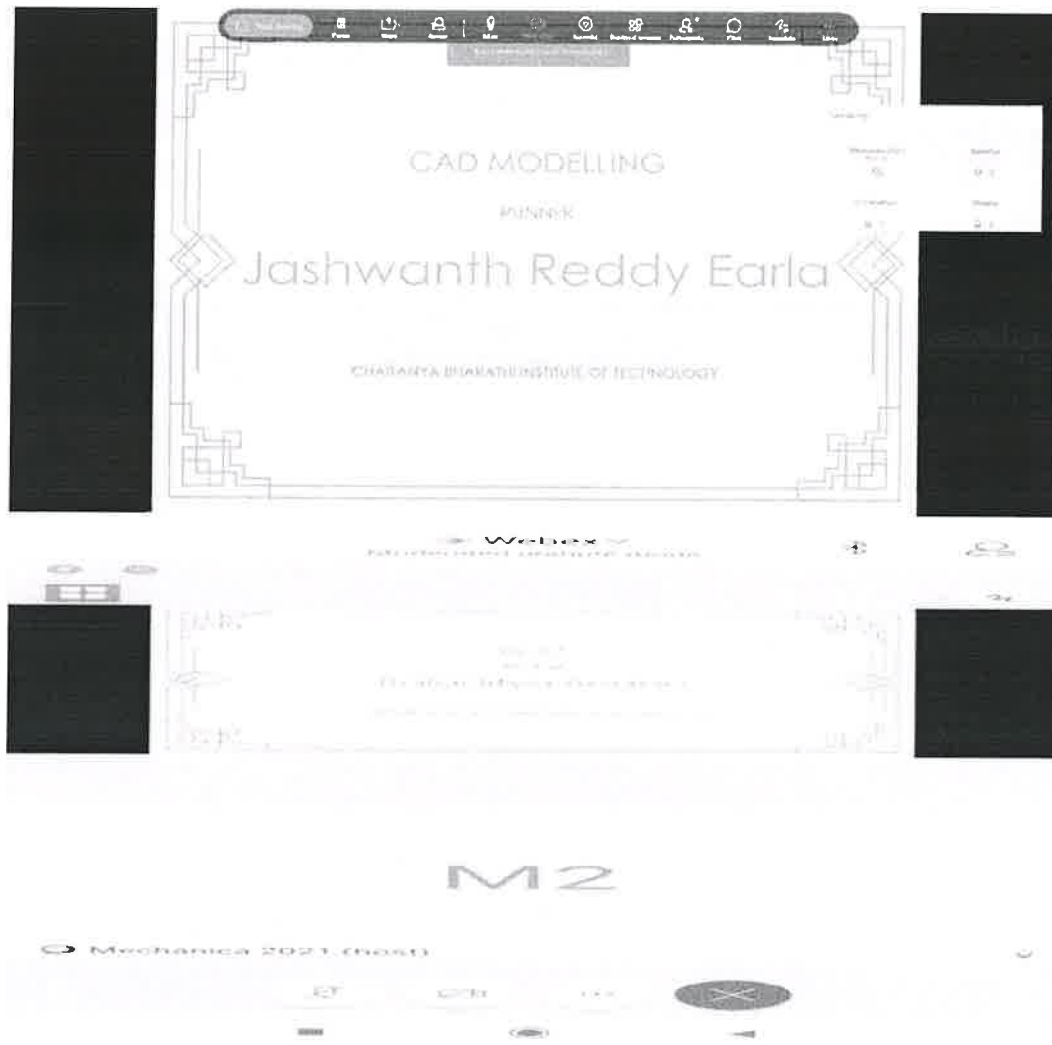

Demographics

The demographics for the event are as follows:

1. 13 other colleges have registrations like CMR, Sasi Institute of Technology & Engineering, Khammam Institute of technology and science, BVRIT HYDERABAD COLLEGE OF ENGINEERING FOR WOMEN, Vardhaman, St.Pious x degree, VASAVI COLLEGE OF ENGINEERING, Teegala Krishna Reddy college of engineering and technology.

Vote of Thanks

We would like to thank CBIT Management, Principal, Head of Mechanical Engineering Department and all Teaching and Non-Teaching Staff of Mechanical Engineering Department for their help and support. We would also like to thank our speakers who gave the participants,



[Handwritten signature]

Principal

**Chaitanya Bharathi Institute of Technology
(Autonomous)**

Gandipet, Hyderabad-500 075.

the much-needed boost and their valuable guidance. We congratulate all the winners and all the participants.



Principal
Chaitanya Bharathi Institute of Technology
(Autonomous)
Gandipet, Hyderabad-500 075.



SYNAPSE-2021

Department of Electronics and Communication Engineering
Supported by IEEE Student Branch CBIT and ISF, CBIT

Details of Event

1. Title of the event: **SYNAPSE - 2021, A National Level Students Technical Symposium organized by Dept. of ECE under SUDHEE - 2021**
2. Coordinators: **Smt. D.Nagadevi, Sri. E. Chandrasekhar**
Assistant Professor, Dept. of ECE, CBIT
3. Duration / Date(s) of EVENT: **3rd and 4th March 2021.**
4. Key Note Speaker: **Dr. T.Surya narayana Murthy, JNTU Vijayanagaram on topic "Security in Wireless Communication".**

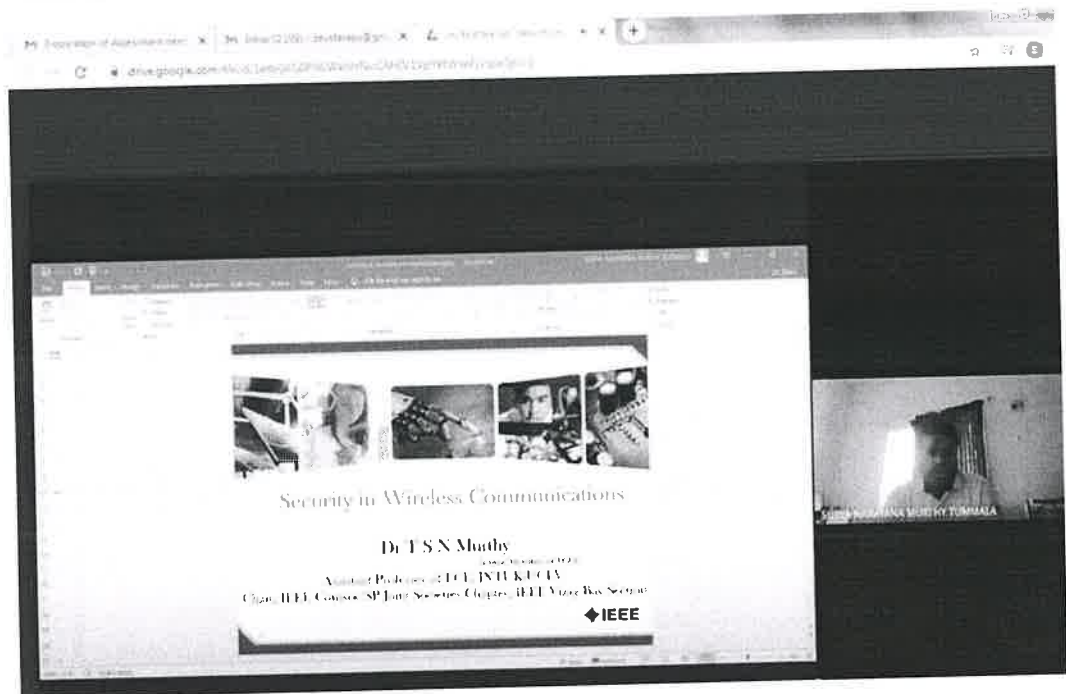

5. List of Events:

1. PAPER PRESENTATION: The 'PAPER PRESENTATION' by SYNAPSE-2021 aims at tapping this infinite potential of human mind to generate an idea and showcase it to the world. The papers to be presented are required to be in the IEEE format.



(Handwritten signature in green ink)

Principal
Chaitanya Bharathi Institute of Technology
(Autonomous)
Gandipet, Hyderabad-500 075.

Event Winners: Dodda Saketh Reddy, ECE CBIT and P.Sai Pranavi Reddy, Pragna D ECE CBIT
No. of Participants: 7

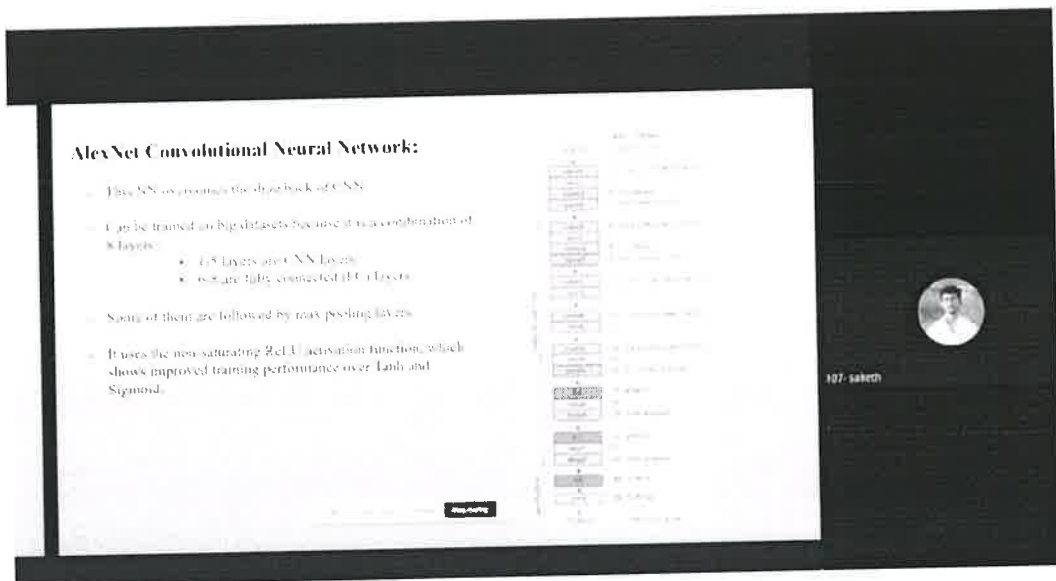

2. POSTER PRESENTATION: The 'Poster Presentation' competition gives you this opportunity to present a summary of your research, project or any of your ideas in a creative and fun way. Your poster should contain all the necessary graphs, charts and other information highlighting your work.
Event Winners: Komatireddy Harish reddy, ECE CBIT and T. Akilesh ECE CBIT
No. of Participants: 5

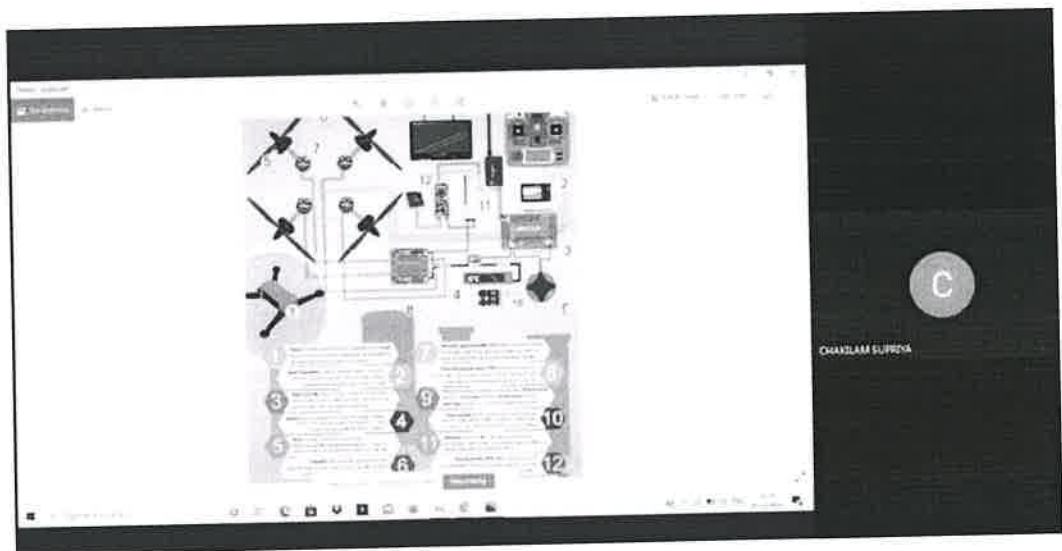

3. PROJECT EXPO under Makers of India, CBIT: The Makers of India is one of the prestigious clubs of CBIT which here goes with a tagline Learn, Innovate, Make. This is a club in which the creator, the learner and the developer meet and exhibit their



P.Sai Pranavi Reddy

Principal
Chaitanya Bharathi Institute of Techno
(Autonomous)
Gandipet, Hyderabad-500 075.

ideas and present. MOI provides a platform to get participants involved with technologies by embedding their technical knowledge into practical use. It witnesses a wide range of creative projects exhibited by students. The expo promises a lucrative array of unique projects that is sure to leave the viewers and participants amazed.

Event Winners: Inhurthi Bhargav EEE, VBIT, Hyderabad and Harika Dasa ECE CBIT
No. of Participants: 26

4. TECHNICAL QUIZ: Synapse's very own quiz event, is the perfect platform for quizzers to flaunt their immense knowledge and amazing reflexes on various technical topics.

Event Winners: Voddula Shravani Reddy and Rohith Reddy S
No. of Participants: 11



5. MOCK INTERVIEWS: Having knowledge of interview questions is crucial but the experience of it is something that cannot be googled! Being confident and spontaneous are key factors to ace any interview. So, synapse is here with the idea of mock interviews, where you get to experience the feel of a real-life Job interview. A clear analysis of performance along with guidance on career path will be given.

Event Winners: Gunturu Srikanth ECE, CBIT and Rohith Reddy S ECE, CBIT
No. of Participants: 14

A handwritten signature in green ink, appearing to be 'P. A. ...'.

Principal
Chaitanya Bharathi Institute of Technology
(Autonomous)
Gandipet, Hyderabad-500 075.



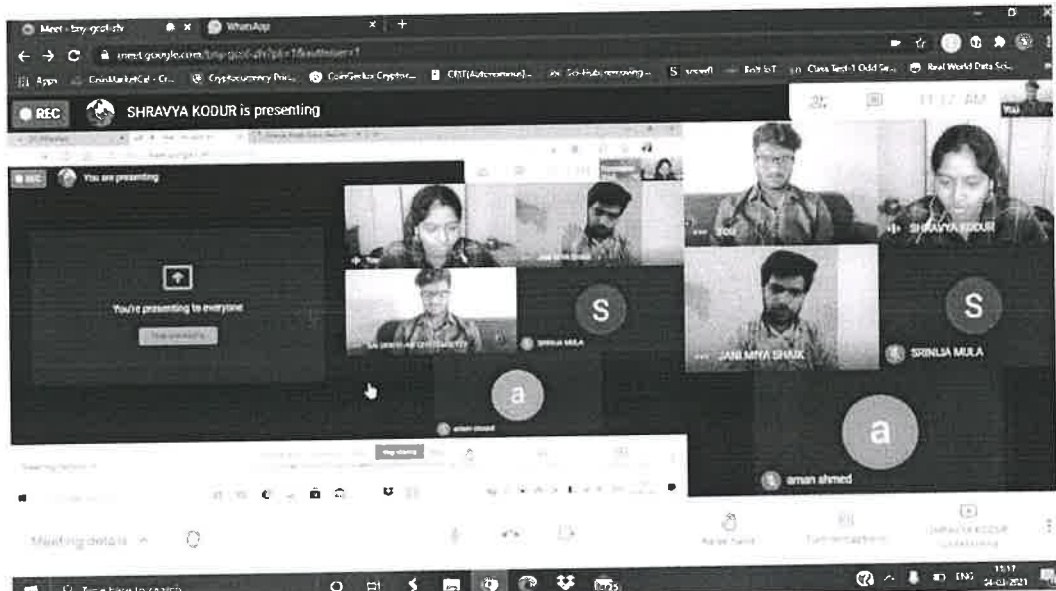

6. ELECTRONICS IN A MINUTE: A topic in one of the domains of Electronics and Communication will be given and the participant should speak relevant points for 1 minute on that said topic.

Event Winners: Thalla Akanksha ECE, CBIT and K.Deepak ECE, CBIT
 No. of Participants: 14

7. DC vs MARVEL : Students form a team and various questions from DC and Marvel series or comics will be asked and team that gets most of the answers right will be the winner.

Event Winners: Devender babu ECE, IIT Roorke and Sai kiran ECE CBIT
 No. of Participants: 9

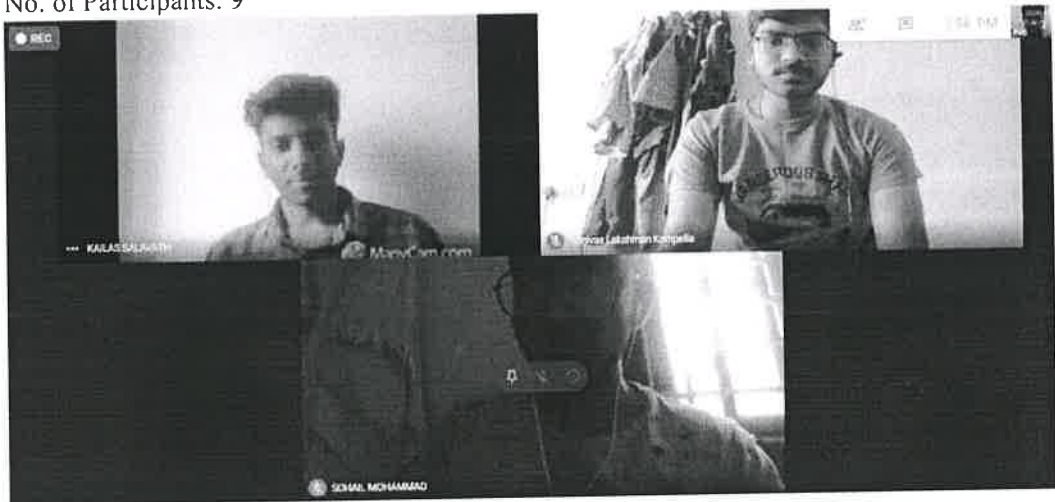

8. TREASURE HUNT: Experience adrenaline rush like never before by taking part in an exciting hunt that will challenge all your senses and wit. The treasure is waiting for you, are you ready to own it? Solve puzzles and decipher clues with your team to win the treasure!!



(Handwritten signature in green ink)

Principal
Chaitanya Bharathi Institute of Technology
(Autonomous)
Gandipet, Hyderabad-500 075.

Event Winners: Thota Tharun ECE, CBIT and Aedunuri Shravya EEE, MGIT
No. of Participants: 24

9. TIP A HAT : A real life problem statement will be given and a group of 2 or 3 students should come up with an interesting solution using their knowledge on electronics and Communication and the best solutions is the winner

Event Winners: HANUMAN SAGAR BATHULA ECE, CBIT and CHETHAN AVINASH REDDY JONNALA ECE, CBIT
No. of Participants: 8

10. MEME IT: Funny yet Though provoking Memes are to be designed based on the given topic.

Event Winners: Vamsi Krishna Chemical, CBIT and M Chanikya ECE, CBIT
No. of Participants: 13

11. TECH DO: TECH - DO is an event which breaks the myth that board games are boring. Similar to the strategic game Ludo, TECH - DO is a tech fun game where your presence of mind and spontaneity are tested the fun way.

Event Winners: Supriya Chakilam ECE, CBIT and Siddharth chaula ECE, CBIT
No. of Participants: 16



12. DCP: Remember those childhood days where crosswords and jigsaw puzzles filled us with zeal? The excitement that follows after a puzzle is solved? DCP - a tech game, is presenting you the opportunity to relive those moments once again!

Event Winners: Dheeraj vamsi ECE, CBIT and Vishnu vardhan ECE, CBIT
No. of Participants: 10



Principal
Chaitanya Bharathi Institute of Technology
(Autonomous)
Gandipet, Hyderabad-500 075.

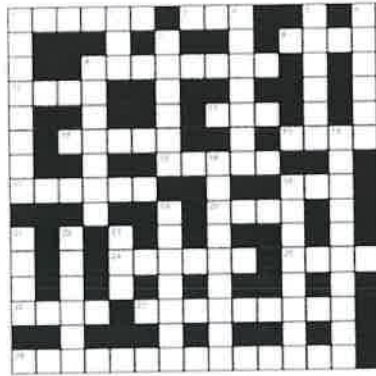

|| meet.google.com is sharing you

Name



Across

1. Become smaller after being washed (6)
4. Washed (6)
8. Don't get concerned about that one (4)
9. American English for British names (5)
10. ...? I heard that Jackson chose a river (4)
11. ... is the opposite of take (4)
12. Jacket worn in the forest (4)
13. ...? There are no ... (6)
15. The ending instructions are in the ... (5)
17. It goes on your neck (4)
19. Put on (6)
20. My chest sounds ... (4)
21. ... (4)
25. Warm and ... (4)
26. Make clothes with wool (4)
27. ... (4)
28. ... (4)

Down

1. ... (6)
2. These grass were supposed to be ... (6)
4. ... (6)
5. ... (6)
6. It is used for keeping things in (4)
7. ... (6)
8. ... (6)
14. The ... (6)
16. ... (6)
18. ... (6)
19. ... (6)
21. ... (6)
22. ... (6)
23. ... (6)



13. Under IETE-CBIT student Forum: "MATLAB workshop" Hand on experience on MATLAB software for students and an event called "Blindfolded Pictionary" was conducted.

No. of Participants: 17

14. ROBOVANZA under Robotics Club CBIT: 8 events were conducted with 29 teams with students of CBIT. The events are All terrain, Robo soccer, Robo maze, Line follower, Robo Race, Blast the balloon, Tug of war, Balance of the line.

[Handwritten Signature]
Principal

Chaitanya Bharathi Institute of Technology
(Autonomous)
...ndipet, Hyderabad-500 075.





No. of Participants: 106

Principal
Chaitanya Bharathi Institute of Technology
(Autonomous)
Gandipet, Hyderabad-500 075.



Report on TECSTASY 2k20

Department of IT has organised TECSTASY 2K21, student technical fest under the aegis of SUDHEE 2K21, on 3rd and 4th March,2021. There are 13 technical events Paper Presentation, Duothon,Tech Fun,Tic Tech Toe, Code Hunt, Trace It, Blind Coding, Brain Boosters, Tech Virus,Meme Tech, Capture the Flag, Techie Connexion,Time Up organized as part of Tecstasy 2k21.

Students from all over the state participated and made it a grand success. Ms. Kratika Sharma and Ms T Satya Kiranmai are the faculty coordinators and Mr Jashwanth T and Ms Devi Abhigna A are the student coordinators.

A keynote address was organised on 03.03.2021 in the Forenoon session. The keynote speaker is Dr Raghavendra Kune, Scientist 'SG' at ISRO,Department of space,Hyderabad.addressed the participants on the topic Head High Performance Computing and Drones.

Various events were organized as part of Tecstasy 2k21.

The detailed descriptions of the events are as follows:

Paper Presentation:A paper presentation event co-ordinated by the faculty Dr. M Venugopal Chary, Ms K Sugamya and Mr Gangadhar Rao. Around 8 technical papers were presented by the students on various emerging technologies.

Time Up: This is a Quiz and Treasure Hunt event Coordinated by the faculty Ms.T Prathima .Around 27 students have Participated.

Capture the Flag :A Cyber security event coordinated by the faculty Mr.Rajesh Kannan.This event is held to attract the interest across cyber security. Around 42 teams have participated.



[Handwritten signature in green ink]

22

71



Principal
Chaitanya Bharathi Institute of Technology
(Autonomous)
Gandipet, Hyderabad-500 075.

Tech Virus: A Technical Quiz event coordinated by the faculty Mr.U Sai Ram .Around 22 teams have participated.

Meme Tech : A Fun event where Memes on Technical content are made and showcased.This event is coordinated by the faculty Ms K Swathi .Around 17 Participants have submitted their memes.

Trace It :A Technical Quiz event coordinated by the faculty Ms.Swathi Sowmya .Around 20 teams have participated.

Code Hunt : A Competitive Coding event coordinated by the faculty Ms R Deepa .Around 33 students have participated.

Techie Connexion: A Technical Quiz event coordinated by the faculty Mr R Govardhan Reddy.Around 27 teams have Participated.

Blind Coding :A Technical Fun event where Typing skills are judged coordinated by the faculty Ms Surya Samantha .Around 25 students have participated.

Brain Boosters: A Technical Problem solving event coordinated by the faculty Mr.Vasantha Sena.Around 50 students have participated.

Duothon:A Four Hour Hackathon event where a team of 2 people code together ,coordinated by the faculty Mr.S Rakesh .Around 15 teams have participated in two slots.



Tic Tech Toe: A Technical Game (with Time constraint) event coordinated by the faculty Ms.Veera Jyothi .Around 48 people have participated.

23



Principal
Chaitanya Bharathi Institute of Technology
(Autonomous)
Gandipet, Hyderabad-500 075.

72

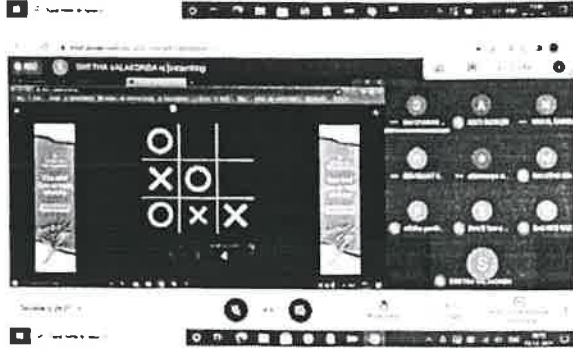

- Tech Fun: A Fun event coordinated by the faculty Ms.B Sarada and around 25 students have participated.

srathya sharma
2/9/2021

[Handwritten signature in green ink]



24

73

Principal
Chaitanya Bharathi Institute of Technology
(Autonomous)
Gandipet, Hyderabad-500 075.

NEOZION 2K21-REPORT

The SUDHEE 2K21 was organized on 3rd and 4th of March 2021. On Day 1 (3rd March), after the inauguration of SUDHEE, our biotech department has inaugurated the Department Event NEOZION 2K21. This edition of Neozion 2K21 is hosted online for the first time from its inception. The event has been started by welcoming all the participants and brief introduction to the department by the Head, Dr Rajasri Y, followed by organization of many technical and non-technical events ranging from Paper Presentations, Poster Presentations, Live Projects, Bio-Hackathon 2.0, Bio-Debate, Bio-Quiz, non-technical events viz., science charades and picture blur. A total of around 100 enthusiastic participants from different places of India viz., Agra, Delhi, Coimbatore, Vijayawada, Punjab, etc. have successfully taken part in different events.

On Day 2 (4th March), the pending technical and non-technical events were conducted by respective faculty event and student coordinators. Keynote delivery on “Tackling Antimicrobial Resistance through digital platforms” was given Dr. Suman Kapur, Sr. Prof, BITS – Pilani (Hyderabad Campus), which oriented with this year’s SUDHEE theme – Digital Innovations. Followed by keynote lecture, valedictory program was conducted by announcing the winners of various technical and non-technical events and thanking all the participants in the vote of thanks by Ms. A. Sneha, Student Coordinator

The final list of participants with respect to each event is given below

S.No	Event	Number of Participants
1	Paper Presentations	22
2	Poster/ Idea Presentations	11
3	Bio-quiz	17
4	Bio-Hackathon	8
5	Debate	13
6	Non-Technical	10



CHEMICAL ENGINEERING DEPARTMENTSUDHEE: CHEMSPARK 2021

A National Level Technical Symposium: 3rd & 4th March 2021REPORT

The Chemical Engg department organized two day National level Technical symposium, CHEMSPARK 2021 on 3rd & 4th March. This technical event, serves as a platform for not only Chemical Engineering but all allied discipline students to present their work and interact with the peer community. The Chemical Engineering field envisages tremendous technology upgrades in different sectors. This event is an endeavour to educate on such technologies through numerous technical activities.

This symposium is designed to provide an interdisciplinary platform for comprehensive dissemination of knowledge and exchange of ideas among student community. In this platform students showcased their knowledge, research findings, creative thinking and effective communication skills in generating innovative solutions for chemical engineering and science issues.

The philosophy of CHEMSPARK 2021 lies in encapsulation of chemical engineering with other process related sectors that will be beneficial for the society and environment. With this lead, prestigious academic institutes such as Indian Institute of Chemical Technology, NIT Warangal, IIIT Basar have presented their research work and contributed for this successful event.

On the opening day, the symposium was inaugurated by distinguished guest Dr. K. Anand Kishore, Professor, Chemical Engineering NITW. He delivered a keynote address on "Frontiers in Chemical Engineering" and has emphasized on the role of Chemical engineers for betterment of society and environment by using water, waste management & greentechnology.



During the afternoon session, the proceedings were put in motion by paper presentations by

15 participants (11 teams) in two technical sessions (conducted parallel) presided by Chemical Engg faculty (Dr. P. V. Naga Prapura, Associate Prof & Dr. Harikrishnan, Assistant Prof for technical session-I; Sri. J. Balakrishna, Assistant Prof & Dr. Harsha Nagar, Assistant Prof for Technical session-II) as judges. The research areas covered were Membrane Technology, Carbon capture, Artificial Intelligence, Nanotechnology, Separation Processes, and Green Technology etc. The sessions were very productive with judges imparting their valuable inputs to the participants and our under graduate students.

The second day was opened with keynote address followed by hands-on session by Dr. Virivinti Nagajyothi, Assistant Professor, Chemical Engg Dept, NIT Trichy. She emphasized on importance & applications of MATLAB in Chemical Engg. ranging from process control, process calculations, numerical manipulation to process simulation and modelling and optimization. The session was attended by department Faculty members & 126 student participants.

In the afternoon, the proceedings have taken place with poster presentations by the 15 participants (7 teams) in two sessions (conducted parallel) presided by Chemical Engg faculty (Dr. M. Kalyani, Assistant Prof & Mr. K. Prasad Babu, Assistant Prof for poster session-I; Dr. B. Ganesh Assistant Prof & Dr. Harsha Nagar, Assistant Prof, for poster session-II) as judges. The technical areas covered were Biofuels, Water management, Petrobased polymers etc. Also, to help students with concentration, identify gaps in knowledge, build confidence and retain information, Technical quiz was also conducted after poster sessions with 20 teams (40 participants).

These two days of symposium (CHEMSPARK 2021) has enhanced the academic interactions and encouraged to promote collaborative research that provides a very broad scope for potential applications in the technical areas covered.

With the active & unstinted support from Management & our Principal Sir along with very positive feedback from the participants comprising of academicians, we look forward to design similar platforms for better collaboration in key technical areas.



Dr. P. Ravindra, HOD
Anitha(Event Chairman)

Dr. P. Madhuri & Dr. M.
(Faculty Co-ordinators)



77

Principal
Chaitanya Bharathi Institute of Technology
(Autonomous)
Gandipet, Hyderabad-500 075.

REPORT ON TECHEON-21

Within a short span of time we started working on TECHEON-21 Poster and MAHESH SHARMA took initiative for creating one. We had great inputs that helped him to modify, one of the input was to add QR CODE that will direct to our Web Site. Website played a major role in promotions and was developed by SAI KIRAN. We uploaded all event posters that were created by Coordinators and a Video Teaser which was prepared by team of MOUNICA, MANJARI, BHARGAVI & SAI SHARAN.

On 22nd Feb Our HOD Sir launched the poster of TECHEON-21 and we got the boost in working and excitement level regarding techeon-21 was at peak.

We collected the responses of all events using separate google forms and got over 500+ responses in 5 days of span. Out of which above 200 were able came up and participate, we received phone calls and messages in a lot on 3rd, many said that they wanted to participate but due to their college timing they were not able to participate.

The student coordinators of Techeon : U.Bhavani & Rishab Verma

The faculty coordinators of Techeon : Dr.B.Indira & CNVBR Sri Gowrinath

The first ever online technical contest TECHEON-21 had received great response from numerous colleges and universities. There were responses from all over India some of which are, NIT Rourkela, Telangana University, Pune University, Osmania University, IIT Hyderabad, IIT Madras, SRM university, Jain University, IGNOU, Sardar Patel University , Kaloji Narayana rao University and may more universities and colleges. In all TECHEON-21 received 567 Responses and 282 Participants.



Principal

Chaitanya Bharathi Institute of Technology
(Autonomous)
Gandipet, Hyderabad-500 075.

Below mentioned are the winners of various events in Techeon -21.

Sr No.	Event Name	Responses/Participants	Winner Name	Runner Up
1	Code Convert	36/11	Devoleena	Mohameed Patel
2	Code Detective	85/25	Poojitha	Rishi
3	Innovative Design Poster Presentation	38/12	Pratyush Sriva	Teja Vyankatesh
4	Lan Gamming	65/19	P Akshita	D Vijay Raj
5	Paper Presentation	11/11	AKHIL CHANDRA/VAMSI KIRAN	Sandeep Kalari
6	Reverse Code	56/19	Naveen	Arun
7	Skribbl	110/65	Maghna	Ankit Pradhan
8	Tech Talk	35/35	Annapurna	K Sandeep
9	Technical Quiz	52/20	Himanshu & Rishika	Krishna & Bhavani
10	Word Chase	105/57	Kamle Abhilash	Yerramshetty Hyma Priyadarshini

(Handwritten signature in green ink)



Principal

**Chaitanya Bharathi Institute of Technology
(Autonomous)
Gandipet, Hyderabad-500 075.**

BRIEF NOTE ON YUKTHI-2K21

YUKTHI-2K21 as a part of SUDHEE-2K21 (A National Level Students' Technical Fest) is being organized on 03.03.2021 and 04.03.2021 at School of Management Studies (SMS), Chaitanya Bharathi Institute of Technology (CBIT), Hyderabad. Under the banner of YUKTHI-2K21 various events were organized namely Paper Presentation, Talent Tech, Young Manager, Bizz Quiz, Idea/Poster Presentation, Advert Mantra and Finnovate.

Programme started on 03.03.2021 with an inaugural session comprising Invocation, Welcome address by Principal, Address by Chairman- SUDHEE, Address by Guest of Honour, address by Chief Guest, Presidential Address by 'Kavi Kireeti' Dr. V. Malakonda Reddy, and concluded with vote of thanks by Convenor.

After the inaugural session, departmental activities have started. YUKTHI-2K21 was officially started with a key note address by Sadhu Srinivasa Pavan Kumar. After the key note address the activities have started.

Paper Presentation on "Disruptive technologies in business practices" was conducted from 02:15 PM to 4:00 PM and the winner is R Renuka from UCC&BM, OU.

Idea/Poster presentation (with the objective is to bring out the innovation, creativity and communication skills among the students) was conducted on 3rd and 4th and the winner is S Mohan.

Bizz Quiz (Business Quiz) event was conducted on 3rd and 4th and the winner is Jagadish with a tagline of "Unlocking Knowledge at the Speed of Thought".

Talent Tech (HR Event) is being organized on 3rd and 4th and the winner is Vikram from Nalsar University with an aim to see that students abilities will be deployed to find the right man for the right place at the right time.

Young Manager (to identify the student with the traits of a good manager) is being organized on 3rd and 4th and the winner is Varun.

Finnovate (Finance Event) is being organized on 3rd and 4th and the winner is Dileep from IIT-Bombay with an aim to bring out the investment and management skills of the students.

Advert Mantra (Marketing Event) is being organized on 3rd and 4th and the winner is Tahseen Ahmed from IPE. The event focused on bringing the latent talent in students especially about novelty, creativity and innovation.





**CHAITANYA BHARATHI
INSTITUTE OF TECHNOLOGY (A)**

Kokapet (Village), Gandipet, Hyderabad, Telangana-500075. www.cbit.ac.in



COMMITTED TO
RESEARCH,
INNOVATION AND
EDUCATION

44
years

Extract of the Audited balance sheet- SHRUTHI and SUDHEE Expenditure- Year 2020-2021-Reg

P MURALI&CO
Chartered Accountants



6-3-655/2/3, Somajiguda, Hyderabad TELANGANA
500082
Ph. 9908950616

FORM NO. 10BB

[See Rule 16CC]

Audit report under section 10(23C) of the Income-tax Act, 1961, in the case of any fund or trust or institution or any university or other educational institution or any hospital or other medical institution referred to in sub-clause (iv) or sub-clause (v) or sub-clause (vi) or sub-clause (via) of section 10(23C).

- (i) We have examined the Balance Sheet as at 31/03/2021 and the Income and Expenditure or Profit and Loss Account for the year ended on that date attached here with of CHAITANYA BHARATHI INSTITUTE OF TECHNOLOGY AABTC1906A (name and PAN of fund or trust or institution or any university or other educational institution or any hospital or other medical institution).

15. STUDENT ACTIVITIES

Particulars	For the	For the
	Year Ended	Year Ended
	2020-21	2019-20
	Rs.	Rs.
SRUTHI Annual Festival Exps	42,26,466	35,73,022
Student Projects	8,000	3,27,438
Students Tours	3,730	38,556
Sports & Games	-	5,49,090
Farewell party	-	29,025
Freshers Party	-	21,155
SUDHEE Expenditure	51,950	10,26,364
Graduation Day	-	14,59,384
Club Expenses	380	-
Students training programme	-	-
Training & Placement Expenses	19,308	-
Student Insurance	26,547	68,655
TOTAL	43,36,381	70,92,689

page 12 of 13

Ref: <https://cbit.ac.in/wp-content/uploads/2021/06/2020-21-BALANCE-SHEET.pdf>



Attestation by Principal

Principal
Chaitanya Bharathi Institute of Technology
(Autonomous)
Gandipet, Hyderabad-500 075.